

Descripción

331N(3/2), 341N(5/2) Electroválvula (válvula de embolo) IP65, cuerpo Aluminio

Características

	331N03 (3/2) 341N03 (5/2)	331N04 (3/2) 341N04 (5/2)
• Orificio	7mm	12mm
• Caudal	1250 l/min	3000 l/min
• Conexión	NAMUR	
• Presión diferencial	min. 1,5 bar, max. 10 bar	
• Temperatura	-10°C ÷ 50°C	

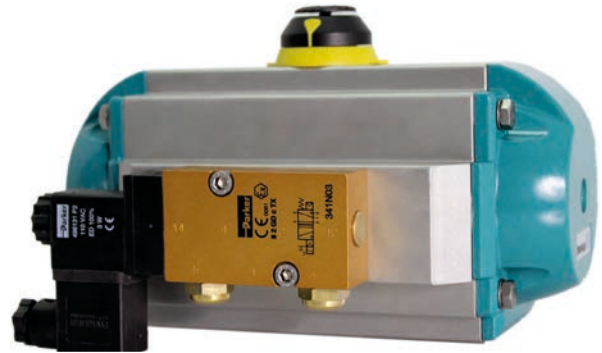

Dimensiones

331N (3/2)

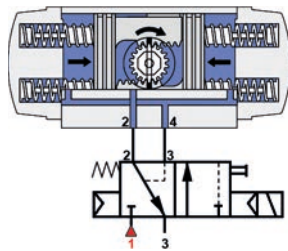
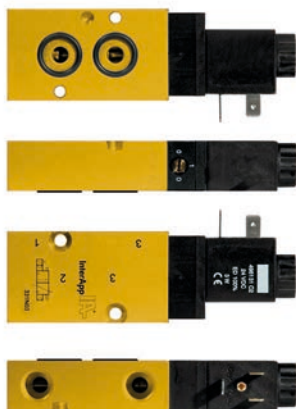

IA050S - IA250S, IA750S

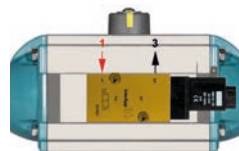

IA300S - IA700S IA800S, IA1000S



IA motion	Electroválvula IP65	[Watt]	L	L1	B	H	1+3	[kg]
IA050S-IA600S	331 N 03, 496131-**.	3	123,7	88,7	40	22	G ¼"	0,30
IA650S-IA1000S	331 N 04, 496131-**.	3	169,0	112,0	60	30	G ½"	0,72

** 12/=, 24/=, 48/=, 24/50, 110/50, 230/50

341N (5/2)

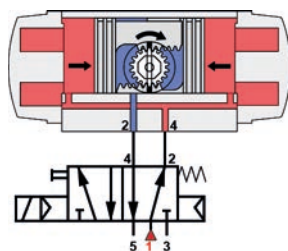
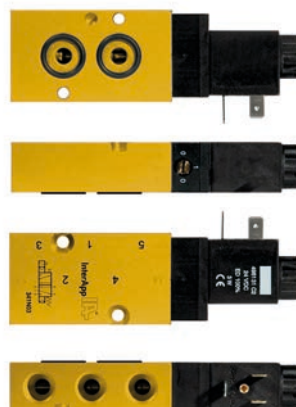

IA050D - IA250D, IA750D

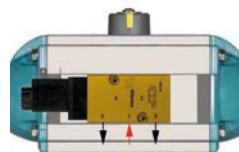

IA300D - IA700D IA800D, IA1000D



IA motion	Electroválvula IP65	[Watt]	L	L1	B	H	1+3+5	[kg]
IA050D-IA600D	341 N 03, 496131-**.	3	123,7	88,7	40	22	G ¼"	0,30
IA650D-IA1000D	341 N 04, 496131-**.	3	169,0	112,0	60	30	G ½"	0,70

** 12/=, 24/=, 48/=, 24/50, 110/50, 230/50



Descripción

5/2 (3/2) Electroválvula (válvula de embolo) IP65, cuerpo Aluminio con anodizado duro

Características

	341N01	341N02	341N34
• Orificio	4mm	8mm	12mm
• Caudal	600 l/min	1400 l/min	3000 l/min
• Conexión		NAMUR	
• Presión diferencial	min. 2 bar, max. 10 bar		
• Temperatura	-25°C ÷ 50°C		



341 N -> EEx m II T5 (Ex II 2 G/D)

Dimensiones

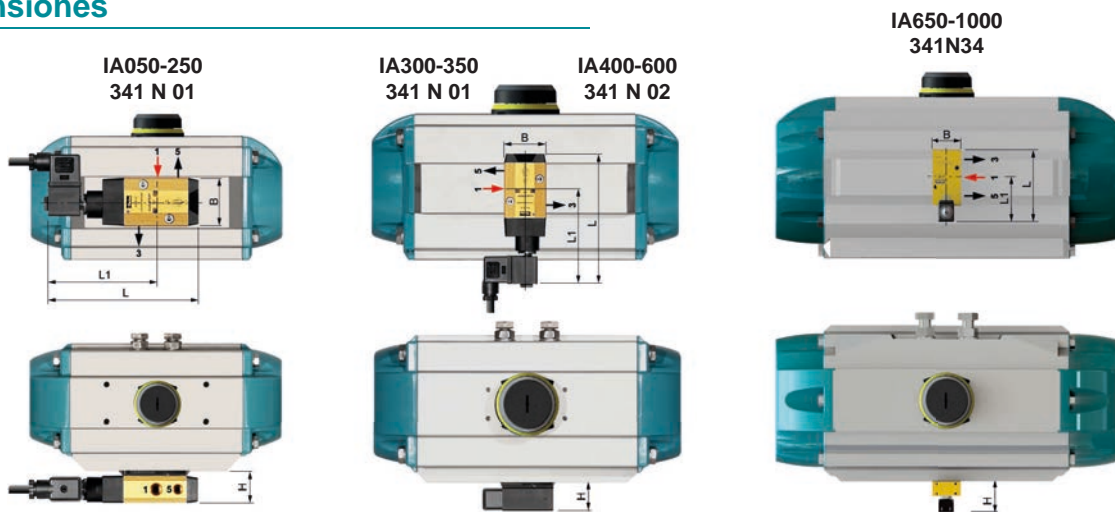

IA motion		Electroválvula IP65	AC / DC	[Watt]	L	L1	B	H	1	3 + 5
IA050 - IA350		341 N 01, 482606-230/50	230V 50Hz	2W	146,7	106,2	46	31,6	G 1/4"	G 1/8"
		341 N 01, 482606-24V/=	24V =	2,5W						
IA400 - IA600		341 N 02, 482606-230/50	230V 50Hz	2W	160,6	115,1	55	40,2	G 1/4"	G 1/4"
		341 N 02, 482606-24V/=	24V =	2,5W						
IA650 - IA1000		341 N 34, 495905-230/50	230V 50Hz	8W	144	87	60	68	G 1/2"	G 1/2"
		341 N 34, 495905-24V/=	24V =	8W						

Cambio de función 5/2 – 3/2:

El cambio de 5/2 a 3/2 (o 3/2 a 5/2) se hace girando la placa intermedia en 180°.

