



ELECTRIC ACTUATORS

for industrial valve automation





ABOUT THIS BROCHURE

This brochure intends to describe functions and possible applications for electric actuators, actuator controls and gearboxes. The document offers an introduction into the topic, an overview on products and founded explanations regarding design and function of electric AUMA actuators.

On the rear pages of this brochure, you will find a chapter with detailed technical data for swift product selection. For device selection, further information can be obtained from our separate specific data sheets. It will be our pleasure to assist you and provide any further details that might be needed.

The latest information on AUMA products can be found on the Internet at www.auma.com. All documents, including dimensional drawings, wiring diagrams, technical and electrical data sheets, as well as inspection certificates are available on the Internet in digital form.

Who are AUMA?	
About this brochure	2
AUMA - The specialist for electric actuators	4
Basics	
Applications	6
What is an electric actuator?	8
SA multi-turn actuators and SQ part-turn actuators	10
Automation solutions for any valve type	12
Service conditions	14
Basic actuator functions	18
Controls concepts	20
Operation and clarity	
Integration within the DCS - AM and AC actuator controls	22
Clearly structured operation	24
Reliability, service life, maintenance - with test engineering features	26
AUMA CDT for AC controls - easy commissioning	28
AUMA CDT for AC controls - diagnostics dialogue	30
Communication	
Communication - tailor-made interfaces	32
Communication - fieldbus	34
Communication - HART	38
SIMA - the fieldbus system solution	40
Alternative communication channels - Wireless and fibre optic cables	42
Design	
Uniform design for SA and SQ	44
Electromechanical control unit	50
Electronic control unit	51
Interfaces	
Valve attachment	52
Electrical connection	54
Solutions for all combinations	
Multi-turn actuator - part-turn gearbox combinations - for large torques	56
Special circumstances - adapting to any mounting position	58
Safety	
Protection for valve, protection during operation	62
Functional safety - SIL	64
Technical data	
SA multi-turn actuators and SQ part-turn actuators	66
AM and AC actuator controls	72
SA/GS part-turn actuators	75
SA/GK multi-turn actuators	79
SA/GST multi-turn actuators	80
SA/GHT multi-turn actuators	81
SQ part-turn actuators with base and lever and SA/GF	82
SA/LE linear actuators	83
Certificates	84
Index	86



Multi-turn actuators: Gate valves



Linear actuators:
Globe valves



Part-turn actuators: Butterfly valves, plug and ball valves



Lever actuators: Dampers



AUMA - THE SPECIALIST FOR ELECTRIC ACTUATORS

Armaturen- Und MaschinenAntriebe - AUMA - are leading manufacturers of actuators for automating industrial valves. Since 1964, the founding year of the company, AUMA have focussed on development, manufacture, sales and service of electric actuators.

The brand name AUMA is synonymous with long-standing experience and knowledge. AUMA are specialised in electric actuators for the energy, water, oil & gas, as well as industrial sectors.

As an independent partner of the international valve industry, AUMA supply customer-specific products for electric automation of all industrial valves.

Modular concept

AUMA are entirely devoted to pursue their modular product concept. A comprehensive range of sub-assemblies allows for configuration of customer-specific actuators accommodating the required application. The range of variants is only possible due to clear interfaces between components while placing the highest demands on product quality as well as easy and straightforward maintenance of AUMA actuators.

Innovation on a day-to-day-business

As specialist for electric actuators, AUMA set the market standard for innovation and sustainability. Within the framework of continual improvement, their own in-house vertical range of manufacture guarantee prompt implementation on both product or sub-assembly level. This applies to all areas relating to device function - mechanical, electrical, electronic, and software engineering.



Success is reflected by growth - worldwide

Since the foundation in 1964, AUMA have evolved into a company with 2,300 members of staff around the globe. AUMA proudly possess a global sales and service network with more than 70 sales organisations and representative offices. According to our customers, AUMA staff are very competent in product consultation and efficient in after-sales service.

Selecting AUMA:

- > provides valve automation in compliance with submitted specifications
- > assures safety for design and implementation for plant engineering on the basis of certified interfaces
- > guarantees the operator global on site service including commissioning, comprehensive support, and product training.



APPLICATIONS

WATER

- > Sewage treatment plants
- > Water treatment plants
- > Drinking water distribution
- > Sewage disposal
- > Seawater desalination
- > Steel constructions for water systems

Drinking water abstraction and distribution, as well as sewage disposal and purification are basic prerequisites for infrastructure development. Security of supply is crucial for modern water industry. Piping of different lengths and nominal diameters must be automated with a multitude of valve types. AUMA actuators are widely used in civil engineering constructions for water applications to operate weirs and sluice gates. AUMA are well implanted in the water industry due to their broad product portfolio including multi-turn, part-turn, and linear actuators. In combination with high corrosion protection, they guarantee a long service life, low in maintenance.

ENERGY

- > Fossil power plants (coal, gas, oil)
- > Nuclear power plants
- > Cogeneration power plants
- > District heating
- > Hydroelectric power plants
- > Geothermal power plants
- > Solar thermal power plants
- > Biogas power plants

Power plants consisting of systems such as water and steam circuits, flue gas purification, cooling tower, boiler systems, and turbines. The control system regulates the processes within these systems to be visualised within the control room. Electric actuators mounted to valves control water and steam flows within piping systems. AUMA actuators offer an interface for all automated valves adapted to the power plant control systems. When used in power plants, AUMA actuators are characterised by their superior tolerance with regard to voltage, vibration, and temperature and can be adapted to any mounting position required.



OIL & GAS

- > Tank farms
- > Platforms
- > Pipelines
- > Refineries
- > Pumping stations

Oil & gas are crucial energy sources for the industry. They are extracted, processed, and distributed using most sophisticated technologies and procedures. Due to the high potential hazards for people and environment, strict sets of regulations must be observed within the oil & gas sector. AUMA are renowned in this industry on an international level, complying with the increasing market demands for vendor list approvals and explosion protection certificates. AUMA actuators fully meet the requirements of the oil & gas industry with their superior SIL capability and usability under most extreme climatic conditions.



INDUSTRY

- > Heating, ventilation & air conditioning
- > Food industry
- > Chemical/pharmaceutical industry
- > Vessel and submarine ship building
- > Steel mills
- > Paper industry
- > Cement industry
- > Mining

Any process technology requires pipes and valves and consequently AUMA actuators. AUMA are in a position to supply tailor-made solutions for various plant-specific requirements. This is possible due to the modular product design.

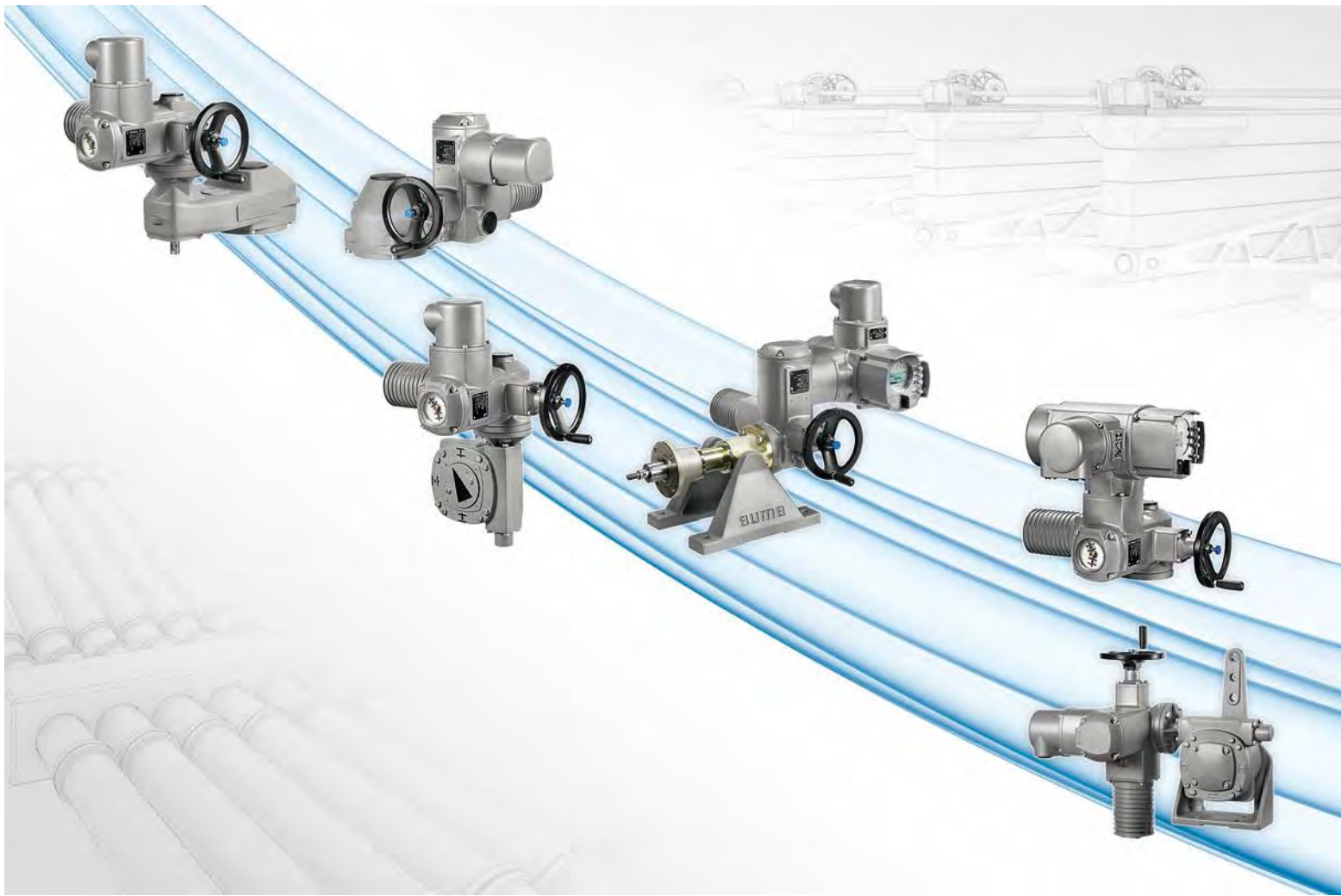

WHAT IS AN ELECTRIC ACTUATOR?

In process technology plants, liquids, gases, vapours, and granulate need to pass through pipelines. Industrial valves are used to inhibit or release medium flow as well as to control the resulting flow rate by opening or closing the valves. AUMA actuators are remotely controlled from the control room to operate valves.

Automating industrial valves

Modern industrial applications are based on a high level of valve automation. This is the requirement for managing complex processes.

The actuator positions the valve in compliance with operation commands issued by the DCS. When reaching end positions or intermediate positions, the actuator stops and signals the status to the control system.

Electric actuators

Electric actuators are equipped with an electric motor/gearbox combination, particularly developed for valve automation, providing the torque required for operating the moving elements of gate or butterfly valves as well as ball and globe valves. Manual valve operation is possible using the handwheel, available as standard. The actuator records travel and torque data from the valve, controls process data and are responsible for switching the actuator motor on and off. Typically, controls are integrated within the actuator and are equipped with a local control unit apart from the electrical interface to the DCS.

The basic requirements for actuators have been specified in the international standard EN 15714-2 since 2009.

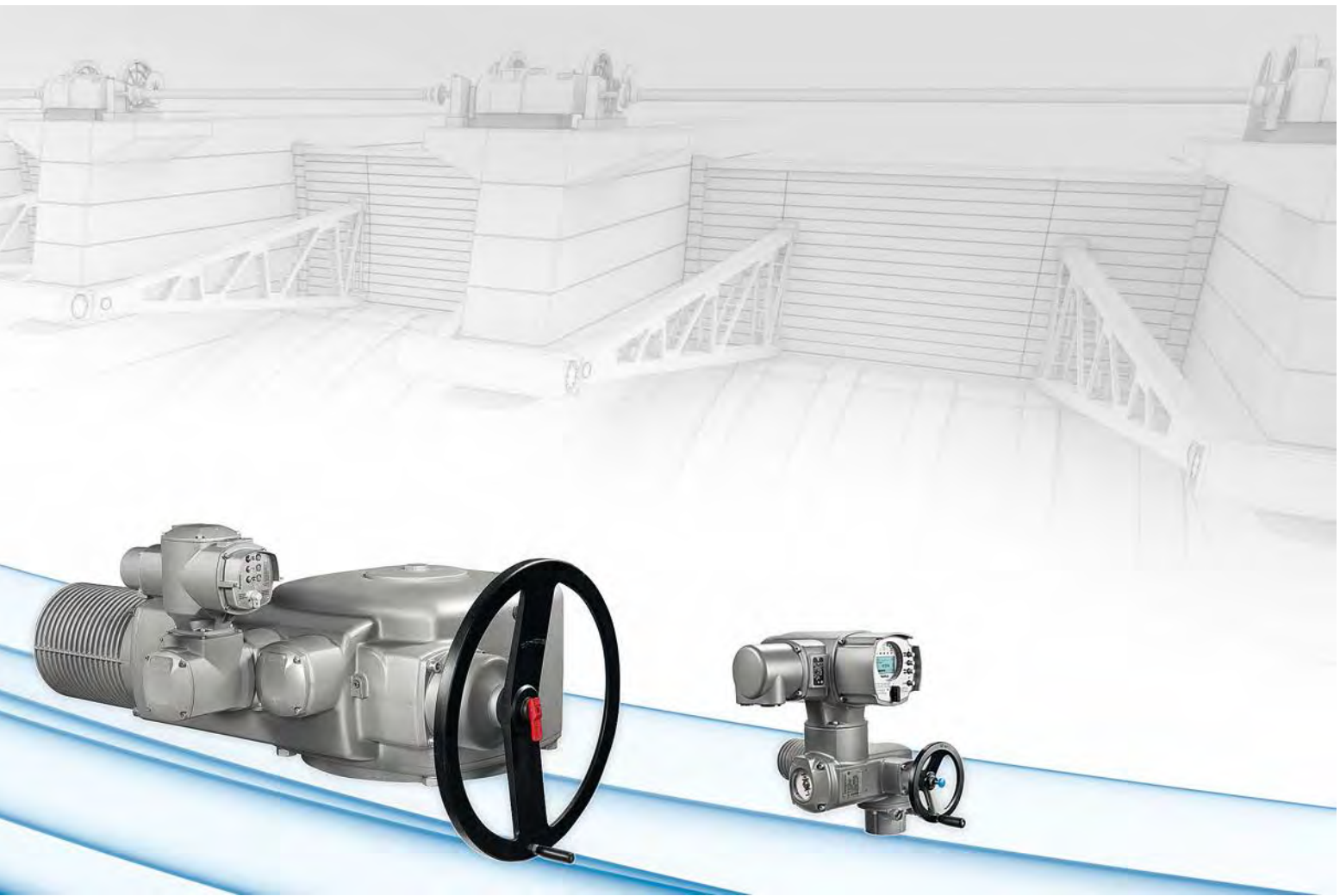

Requirement for diversity

Process engineering plants with pipe systems and valve automation are required all around the globe. Not only types of plants and valves are crucial factors for electric actuators but also the climatic conditions in which they are operated. AUMA actuators guarantee reliable and safe service under most extreme environmental conditions.

International test authorities confirm the quality of AUMA actuators designed, manufactured and tested to customer specifications by issuing product certificates.

As an independent manufacturer, AUMA can look back on long-standing experience and collaboration with the valve industry, plant engineering companies and end users of process plants in sectors such as energy, water, oil & gas, and industry.

Requirement for reliability

Process engineering plants are only efficient, economically viable and safe if all components involved provide reliable service during the entire lifetime. Many plants are scheduled for lifetimes of several decades. Consequently, reliable actuator service is expected during all this time. Of course, AUMA can continue to supply spare parts for types ranges which are scheduled to be discontinued for quite a long time period.



SA MULTI-TURN ACTUATORS AND SQ PART-TURN ACTUATORS

The actuation mode is considered a significant distinction factor between the different valve types.

A typical example of multi-turn valves are gate valves. They require a defined number of turns at valve input for a complete valve stroke from CLOSED to OPEN and vice versa.

Butterfly valves or ball valves are typically used if part-turn movements up to 90° are required for the entire travel.

Globe valves are normally operated via linear movement. Furthermore, certain valves are operated via lever arrangements. In this case, we are talking about lever movement.

Specific types of motion require specific actuator types.

Type ranges SA multi-turn actuators and SQ part-turn actuators are the core products of the AUMA product portfolio.

AUMA actuators

The basic function of AUMA actuators is the same across all products.

The gearing is driven by an electric motor. The torque applied at the gearing output is transmitted to the valve via a standardised mechanical interface. A control unit within the actuator records travel and monitors torque applied. When reaching a valve end position or a predefined torque limit, the control unit sends a signal to motor controls. Upon receiving this signal, motor controls typically integrated within the actuator stop the actuator. Motor controls are equipped with an appropriate electric interface adapted to the DCS to exchange operation commands and feedback signals between motor controls and DCS.

SA multi-turn actuators and SQ part-turn actuators

Both type ranges are designed on the same principle; commissioning and operation are virtually identical.

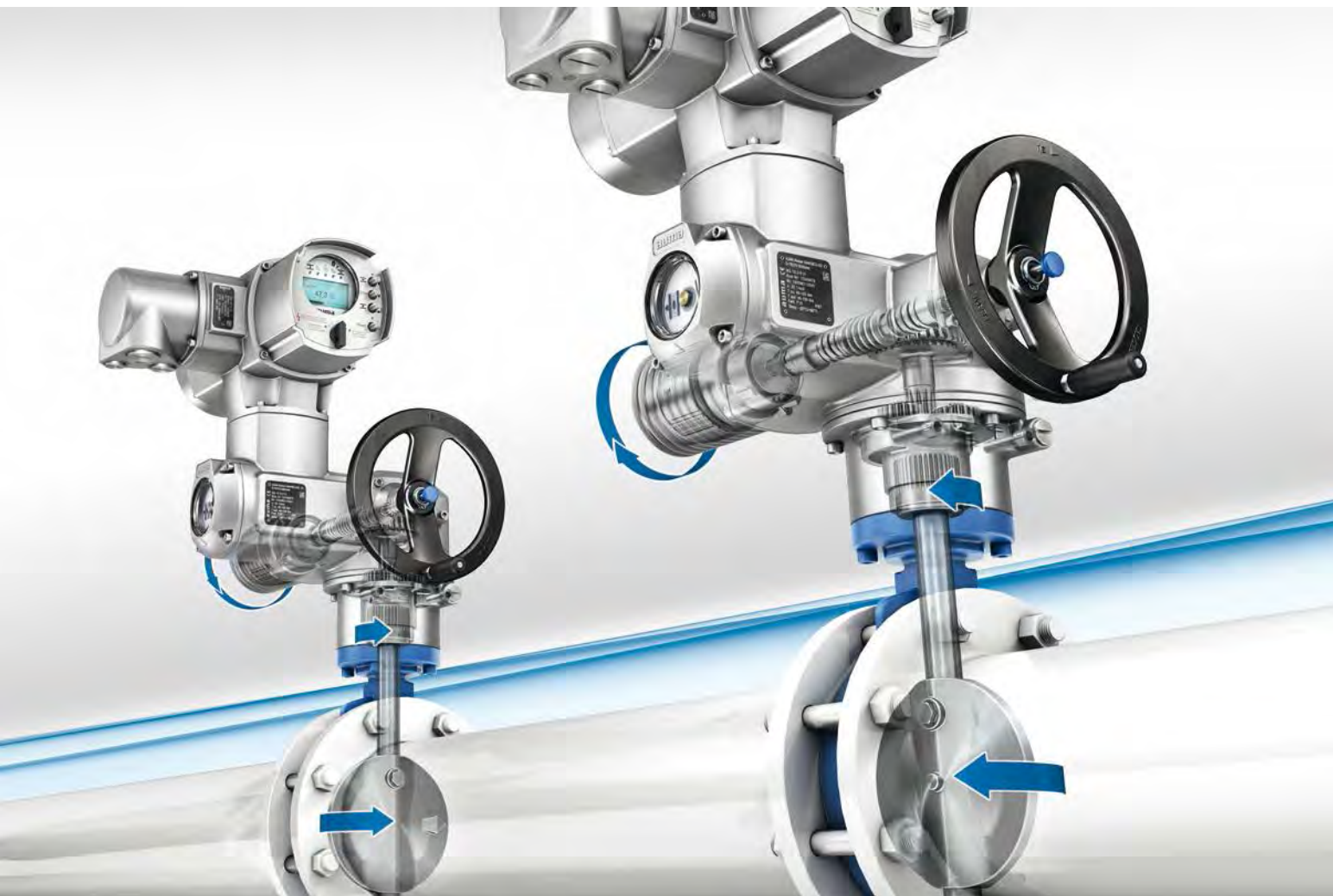

SA multi-turn actuators

In compliance with EN ISO 5210, a multi-turn actuator is capable of withstanding thrust applied to the valve and transmits torque to the valve for at least one revolution. In general, multi-turn actuators are required to perform more than one revolution. Consequently, gate valves are often equipped with rising valve stems. They are operated on the basis of several revolutions performed by the multi-turn actuator. Therefore, the multi-turn actuator is equipped with a hollow shaft housing the gate valve stem for these applications.

SQ part-turn actuators

In compliance with EN ISO 5211, part-turn actuators transmit torque to the valve for a rotation of one revolution or less. They do not have to be capable of withstanding axial thrust.

Part-turn valves - such as butterfly valves and ball valves - are often designed in multi-turn version. SQ part-turn actuators are equipped with internal end stops to allow precise approaching of end positions during handwheel operation.

SA multi-turn actuators with mounted gearbox

The application range is considerably increased by mounting AUMA gearboxes to SA multi-turn actuators.

- > We obtain a linear actuator in combination with LE linear thrust unit.
- > We obtain a lever actuator in combination with GF lever gearbox.
- > In particular when requiring higher torques, we obtain a part-turn actuator when combining with GS gearbox.
- > A multi-turn actuator with higher output torque is obtained when combining with GST or GK multi-turn gearboxes. Apart from this, solutions for special valve types or installations can be implemented.

AC 01.2 ACTUATOR CONTROLS

- > Microprocessor-based with enhanced functions
- > Fieldbus communication
- > Display
- > Diagnostics
- > etc.



AM 01.1 ACTUATOR CONTROLS

- > Simple controls providing basic functions



MULTI-TURN ACTUATORS SA 07.2 – SA 16.2 AND SA 25.1 – SA 48.1

- > Torques: 10 Nm – 32,000 Nm
- > Automation of gate and globe valves



COMBINATIONS WITH GK MULTI-TURN GEARBOXES

- > Torques: up to 16,000 Nm
- > Automation of double-stem gate valves
- > Solutions for special installation conditions



COMBINATIONS WITH GST MULTI-TURN GEARBOXES

- > Torques: up to 16,000 Nm
- > Automation of gate valves
- > Solutions for special installation conditions



COMBINATIONS WITH GHT MULTI-TURN GEARBOXES

- > Torques: up to 120,000 Nm
- > Automation of gate valves with large torque requirements

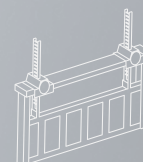

COMBINATIONS WITH LE LINEAR THRUST UNITS

- > Thrusts: 4 kN – 217 kN
- > Automation of globe valves

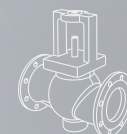

COMBINATIONS WITH GS PART-TURN GEARBOXES

- > Torques: up to 675,000 Nm
- > Automation of butterfly valves, ball and plug valves

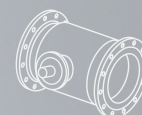

COMBINATIONS WITH GF LEVER GEARBOXES

- > Torques up to 45,000 Nm
- > Automation of butterfly valves with lever arrangements



ELECTRIC PART-TURN ACTUATORS SQ 05.2 – SQ 14.2

- > Torques: 50 Nm – 2,400 Nm
- > Automation of butterfly valves, ball and plug valves

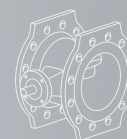

PART-TURN ACTUATORS SQ 05.2 – SQ 14.2 WITH BASE AND LEVER

- > Torques: 50 Nm – 2,400 Nm
- > Automation of butterfly valves with lever arrangements



AUMA devices are used all around the globe and are subjected to all environmental conditions for providing reliable service meeting the specified life endurance criteria.

ENCLOSURE PROTECTION

SA and SQ AUMA actuators are supplied in increased enclosure protection IP68 in compliance with EN 60529. IP68 means protection against continuous immersion up to 8 m head of water for max. 96 hours. During continuous immersion, up to 10 operations are permissible.

Typically, AUMA gearboxes are used in combination with AUMA multi-turn actuators. Gearboxes are also available in enclosure protection IP68. Certain gearboxes are intended for particular applications, e.g. buried service for part-turn gearboxes or superior immersion levels. For any special characteristics, please contact AUMA for device selection.

SERVICE CONDITIONS



AMBIENT TEMPERATURES

Irrespective of the ambient environment - hot or cold - AUMA actuators guarantee reliable service. Adapted temperature versions are available to suit various ambient environments.

Type of duty	Types	Temperature range	
		Standard	Options
Open-close duty, positioning duty (classes A and B)	SA or SQ	-40 °C ... +80 °C	-60 °C ... +60 °C; 0 °C ... +120 °C
	SA or SQ with AM controls	-40 °C ... +70 °C	-60 °C ... +60 °C
	SA or SQ with AC controls	-25 °C ... +70 °C	-60 °C ... +60 °C
Modulating duty (class C)	SAR or SQR	-40 °C ... +60 °C	-40 °C ... +80 °C -60 °C ... +60 °C
	SAR or SQR with AM controls	-40 °C ... +60 °C	-40 °C ... +70 °C -60 °C ... +60 °C
	SAR or SQR with AC controls	-25 °C ... +60 °C	-25 °C ... +70 °C -60 °C ... +60 °C

Further temperature ranges on request



The efficient AUMA corrosion protection is decisive for a high life endurance level of the devices. The AUMA corrosion protection system is based on a chemical preliminary treatment, followed by a two-layer powder coating of the individual components. In compliance with the corrosivity categories according to EN ISO 12944-2, various AUMA corrosion protection levels are provided to suit the different applications.

Colour

The standard colour is silver-grey (similar to RAL 7037). Other colours are available.

Corrosivity categories according to EN ISO 12944-2 Classification of environments		SA, SQ actuators and AM, AC controls	
		Corrosion protection class	Total film thickness
C1 (very low):	Heated buildings with clean atmospheres	KS	140 µm
C2 (low):	Unheated buildings and rural areas with low level of pollution		
C3 (medium):	Production rooms with humidity and some air pollution. Urban and industrial atmospheres with moderate sulphur dioxide pollution		
C4 (high):	Chemical plants and areas with moderate salinity		
C5-I (very high, industrial):	Industrial areas with almost permanent condensation and with high pollution.		
C5-M (very high, marine):	Coastal and offshore areas with high salinity, almost permanent condensation and with high pollution.		
Corrosivity categories for requirements beyond EN ISO 12944-2			
Extreme (cooling tower):	Coastal and offshore areas with extremely high salinity, permanent condensation and high pollution	KX KX-G (aluminium-free)	200 µm

The AUMA corrosion protection system is certified by TÜV Rheinland.

SERVICE CONDITIONS



POWDER COATING - COATING STRUCTURE

Housing

Conversion layer

Functional coating to increase paint adherence to the housing surface.

First powder layer

Powder layer based on epoxy resin. The layer ensures optimal adherence between housing surface and finish coating.

Second powder layer

Powder layer based on polyurethane. The layer is a resistance barrier against chemicals and weathering. The optimal degree of cross-linking of the cured powder results in a significant mechanical resistance. The standard colour is AUMA silver-grey, similar to RAL 7037.

Explosion-proof devices are designed so that they will not act as ignition source for a potentially explosive atmosphere. They will neither generate sparks nor hot surfaces.

For further classifications, please refer to the brochure “Electric actuators for the automation of valves in the oil and gas industry”.

Explosion protection classification for Europe and in accordance with international IEC standard (selection)

Actuators	Ambient temperature range		Explosion protection
	min.	max.	
Europe - ATEX			
Multi-turn actuators SAEx/SAREx 07.2 – 16.2	-60 °C	+60 °C	II 2 G Ex de IIC T4/T3; II 2 G Ex d IIC T4/T3
Multi-turn actuators SAEx/SAREx 07.2 – 16.2 with AMExC or ACExC	-60 °C	+60 °C	II 2 G Ex de IIC T4/T3; II 2 G Ex d IIC T4/T3
Multi-turn actuators SAEx/SAREx 25.1 – 40.1	-50 °C	+60 °C	II 2 G Ex ed IIB T4
Part-turn actuators SQEx/SQREx 05.2 – 14.2	-60 °C	+60 °C	II 2 G Ex de IIC T4/T3; II 2 G Ex d IIC T4/T3
Part-turn actuators SQEx/SQREx 05.2 – 14.2 with AMExC or ACExC	-60 °C	+60 °C	II 2 G Ex de IIC T4/T3; II 2 G Ex d IIC T4/T3
International/Australia - IECEx			
Multi-turn actuators SAEx/SAREx 07.2 – 16.2	-60 °C	+60 °C	Ex de IIC T4/T3 Gb; Ex d IIC T4/T3 Gb
Multi-turn actuators SAEx/SAREx 07.2 – 16.2 with AMExC or ACExC	-60 °C	+60 °C	Ex de IIC T4/T3 Gb; Ex d IIC T4/T3 Gb
Multi-turn actuators SAEx/SAREx 25.1 – 40.1	-20 °C	+60 °C	Ex ed IIB T4 Gb
Part-turn actuators SQEx/SQREx 05.2 – 14.2	-60 °C	+60 °C	Ex de IIC T4/T3 Gb; II 2 G Ex d IIC T4/T3 Gb
Part-turn actuators SQEx/SQREx 05.2 – 14.2 with AMExC or ACExC	-60 °C	+60 °C	Ex de IIC T4/T3 Gb; II 2 G Ex d IIC T4/T3 Gb



Valves are driven in compliance with the required application and their design. Actuator standard EN 15714-2 distinguishes between three applications:

- > Class A: OPEN-CLOSE duty.
The actuator is required to drive the valve through its entire travel from the fully open position to the fully closed position or vice versa.
- > Class B: Inching/positioning or positioning duty.
The actuator is required to occasionally drive the valve to any position (fully open, intermediate and fully closed).
- > Class C: Modulation or modulating duty.
The actuator is required to frequently drive the valve to any position between fully open and fully closed.

Switching frequency and motor operation mode

Modulating duty and open-close duty subject the actuator to different mechanical loads. Consequently, special actuator types are available for each operation mode.

The types of duty for actuators in compliance with IEC 60034-1 and EN 15714-2 (also refer to page 70) are typical distinction criteria. For modulating duty, additional indication is made of the permissible number of starts.

Actuators for open-close duty and positioning duty (classes A and B or types of duty S2 - 15 min/30 min)

AUMA actuators for open-close and positioning duty are identified by type designations SA and SQ:

- > SA 07.2 – SA 16.2
- > SA 25.1 – SA 48.1
- > SQ 05.2 – SQ 14.2

Actuators for modulating duty (class C or types of duty S4 - 25 %/50%)

AUMA actuators for modulating duty can be identified by type designations SAR and SQR:

- > SAR 07.2 – SAR 16.2
- > SAR 25.1 – SAR 30.1
- > SQR 05.2 – SQR 14.2

BASIC ACTUATOR FUNCTIONS

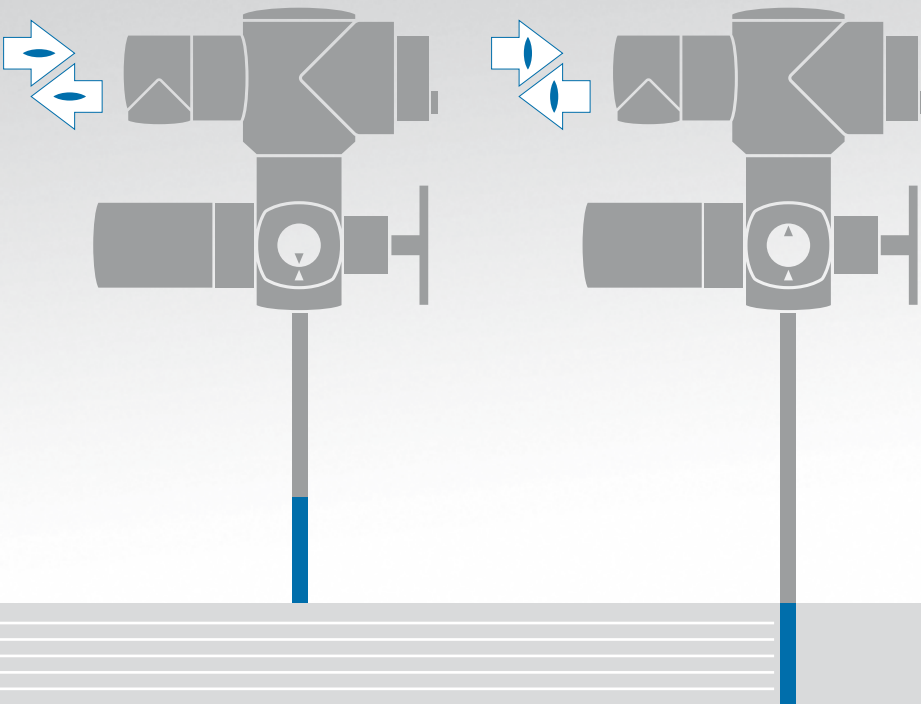

OPEN - CLOSE control

This is the most typical type of control. During operation, control commands Run OPEN and Run CLOSE as well as feedback signals End position OPEN and End position CLOSED are usually sufficient.

Automatic switching off is made either via limit seating or torque seating.

An actuator will be switched off once the end position is reached. Two switch-off mechanisms are available and applied depending on the type of valve.

> **Limit seating**

Controls automatically switch off the actuator as soon as the preset seating position in one end position is reached.

> **Torque seating**

Controls automatically switch off the actuator as soon as the preset torque is applied at the valve end position.

For actuators without integral controls, the type of seating must be programmed within the external control system. For actuators equipped with AM or AC integral controls, the type of seating is set at controls level. The type of seating might differ for each of both end positions.

Overload protection for the valve

If an excessive torque is applied during travel, e.g. due to a trapped object within the valve, the controls switch off the actuator to protect the valve.

Thermal motor protection

AUMA actuators are equipped with thermostats or PTC thermistors within the motor windings. They trip as soon as the temperature within the motor exceeds 140 °C. Embedded within the controls, they optimally protect the motor winding against overheating.

Thermostats or PTC thermistors offer better protection than thermal overload relays since the temperature rise is measured directly within the motor winding.

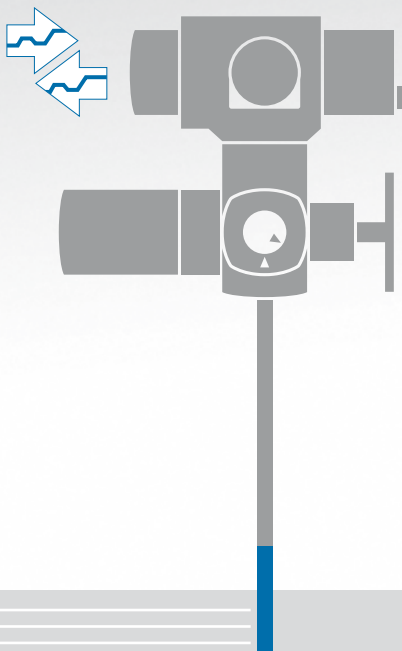

Setpoint control

Controls receive a position value from the host DCS, e.g. as 0/4 – 20 mA signal. The integral positioner compares this value with the current valve position and operates the actuator until actual value equals setpoint. The valve position is transmitted to the DCS.

Actuators



SA NORM



SA - AM



SA - AC

System components



Connection terminals



Fuse protection



Controls



Switchgear



Local controls

Leitungen

- Power supply
L1, L2, L3, PE
- Parallel wiring
Output contacts, signal inputs and outputs
- Serial wiring
Fieldbus
- Number of cable wires

Control concept efforts

- Planning efforts
- Installation efforts
- Commissioning efforts
- Documentation efforts

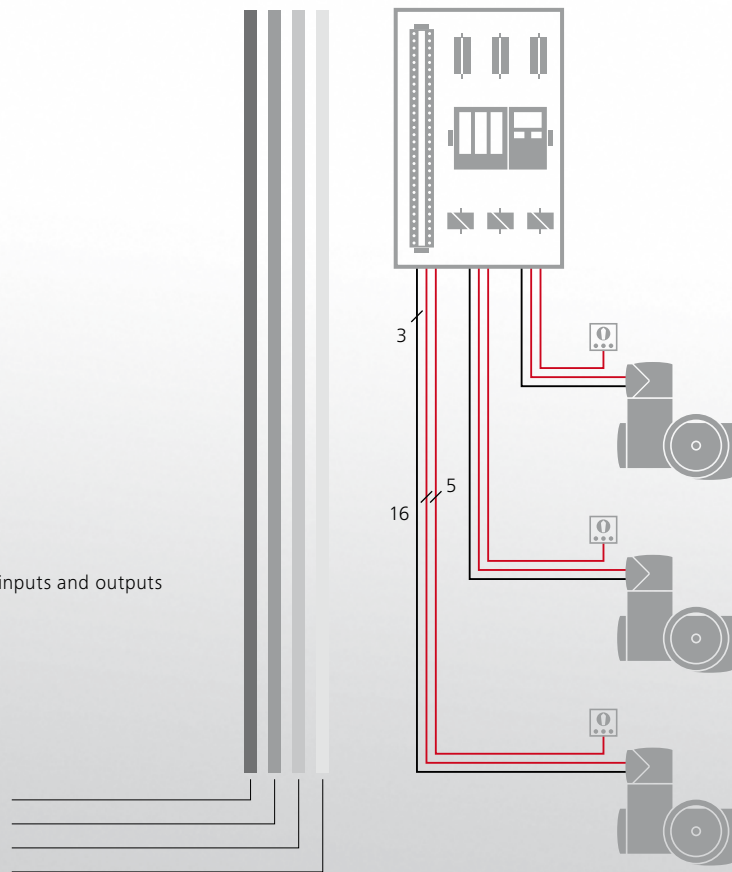

CONTROLS CONCEPTS

AUMA actuators can be integrated into any automation system. Product selection in favour of actuators with integral controls saves time-consuming project planning, installation, and additional documentation which is required when selecting external controls. A further benefit in favour of integral controls is easy commissioning.

External controls

For this controls concept, all actuator signals such as limit switch signals, torque switch signals, motor protection and valve position (if required) are transmitted to an external control system and further processed. When designing controls' architecture, care must be taken to consider the required protective mechanisms and to minimise delay time.

Switchgear for motor controls is installed within a control cabinet and wired accordingly to the actuator.

If local controls are required, they have to be installed in vicinity of the actuator and integrated with external controls.

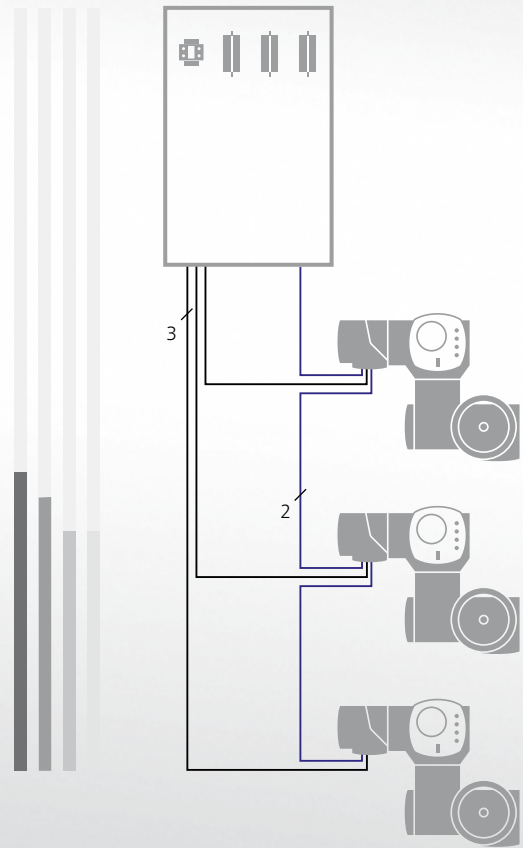
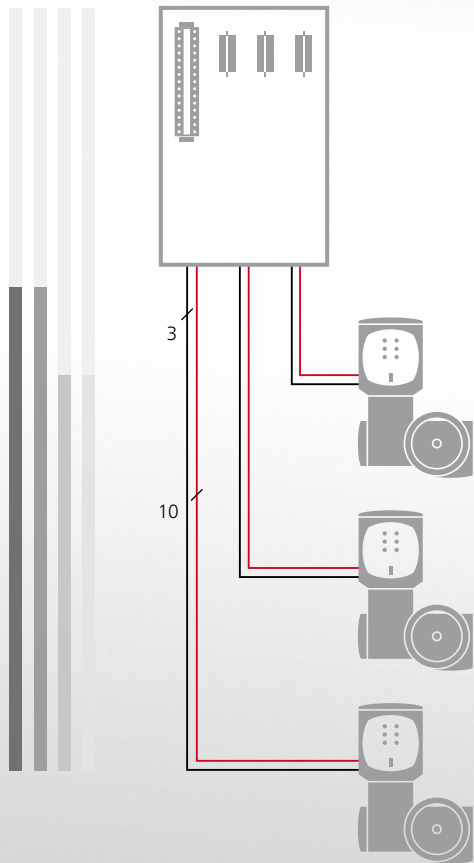

Integral controls

Once power supply has been established, actuators equipped with integral controls can be operated via the operation elements on the local controls. The controls are perfectly adapted to the actuator.

The actuator can be completely set locally, without requiring direct connection to the DCS. Only operation commands and feedback signals are exchanged between the control system and the actuator. Motor switching is performed within the device and virtually without delay.

AUMA actuators are available with AM or AC integral controls.

Fieldbus

In fieldbus systems, all actuators are linked to the DCS via conventional 2-wire cables. All operation commands and feedback signals between actuators and DCS are exchanged by means of these cables.

Input and output sub-assemblies become obsolete when applying fieldbus wiring thus reducing space requirements within the control cabinet. Use of two-wire cables simplifies commissioning and saves cost in particular if long cables are required.

A further advantage of fieldbus technology is that additional information on preventive maintenance and diagnostics can be transmitted to the control room. Thus, fieldbus technology forms the basis for integrating fieldbus devices within Asset Management Systems supporting safeguarding of plant availability.

AUMA actuators with AC integral actuator controls are available with interfaces to all typical fieldbus systems within process automation.



INTEGRATION WITHIN THE DCS - AM AND AC ACTUATOR CONTROLS

Integral controls evaluate actuator signals and operation commands and switch the motor on and off without delay, using the installed reversing contactors or thyristors.

After analysis, the controls supply the actuator signals as feedback signals to the host level.

The integral local controls allow for local actuator operation.

AM and AC controls can be combined with both SA and SQ actuators. This creates a homogeneous picture for the DCS.

Please refer to page 74 for a detailed overview of the controls' functions.

AM 01.1 AND AM 02.1 (AUMA MATIC)

AM controls with simple design and defined features are the perfect choice when using parallel signal transmission and if a relatively low number of feedback signals is required.

Several parameters can be defined via DIP switches during commissioning, e.g. type of seating in end positions.

Actuator control is made via operation commands OPEN, STOP, CLOSE. Reaching an end position and collective fault signals are reported back to the DCS as feedback signals. These signals are visually displayed at the local controls via the indication lights. As an option, the valve position can be transmitted as 0/4 – 20 mA signal to the DCS.



AC 01.2 (AUMATIC)

AC controls are your perfect solution if the application requires self-adapting control functions, data logging, configurable interface or if valve and actuator are to be integrated into a Plant Asset Management System due to advanced diagnostic functions.

AC controls are equipped with a parallel interface for free configuration and/or interfaces to fieldbus systems as used within process automation.

The diagnostic functions comprise a time-stamped event report, torque characteristics logging, continuous recording of temperatures and vibration within the actuator and, furthermore, counting the number of starts and motor running times.

Further to the basic functions, AC controls offer a number of options to meet special demands. These include torque by-pass to unseat valves if tightly seated or functions for extending operating times to avoid water hammer within pipelines.

With the development of the AC 01.2, particular emphasis was laid on user-friendliness and the ease of integration of actuators into the DCS. The large graphic display is used to perform menu-controlled programming of the controls, optionally using AUMA CDT (refer to page 28) via wireless Bluetooth connection. For fieldbus connections, AC programming can be performed from the control room.



CLEARLY STRUCTURED OPERATION

Modern actuators can be adapted to special application requirements by a multitude of parameters. Monitoring and diagnostic functions generate signals and collect operating parameters.

For AC controls, accessing the considerably more detailed data is facilitated by a clearly structured and intuitive user interface.

All device settings can be performed without requiring any additional parameterisation tool.

The display structure is user-friendly, in plain text and available in a large number of languages.

Password protection

The AC password protection is an important safety function. This feature prevents non-authorized persons from modifying defined settings.

1 Display

The graphic display shows texts and graphic elements as well as characteristics.

2 Indication lights

Visual status signals via indication lights can be programmed. Signals indicated via LEDs are clearly visible even from longer distances.

3 Selecting the control mode

The selector switch LOCAL - OFF - REMOTE is used to define whether the actuator is operated from remote (Remote control) or via the local controls (Local control).

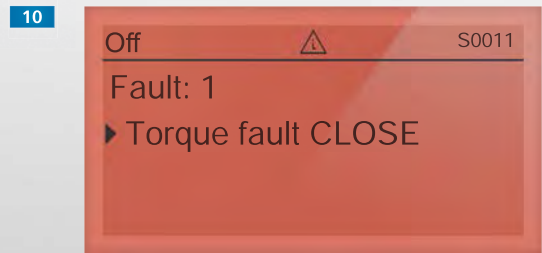
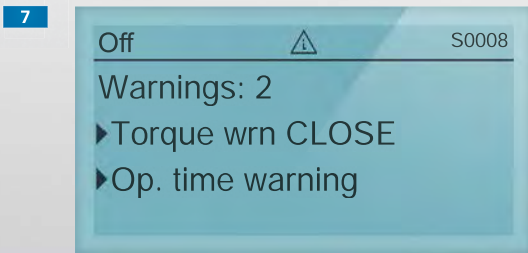
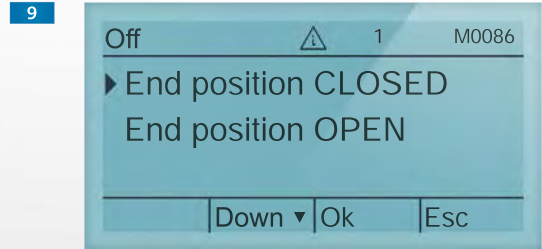
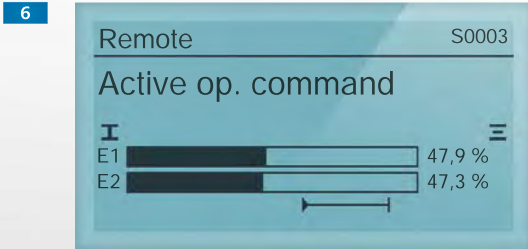
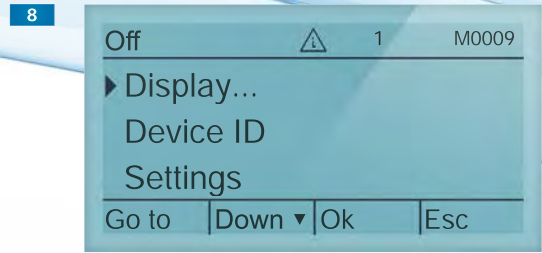
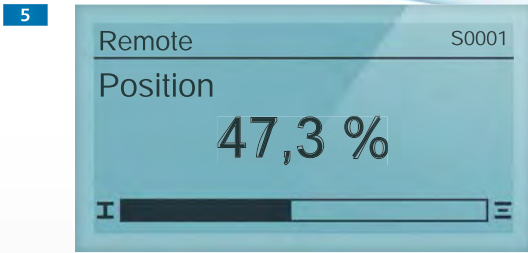

4 Operation and parameterisation

Depending on the selector switch position, the push buttons enable either electric actuator operation, status signals requests or menu navigation.

5 Displaying the valve position

The large display screen allows valve position indication that is even clearly recognisable from longer distances.

6 Displaying operation commands/setpoints

Operation commands and setpoints emitted from the DCS can be displayed.

7 Diagnostics/monitoring displays

Environmental conditions are continuously monitored during active operation. When exceeding permissible limits e.g. operating time, AC controls generate a warning signal.

8 Main menu

The main menu allows actuator data requests and operation parameter modifications.

9 Non-Intrusive setting

If the actuator is equipped with an electronic control unit (refer to page 51), the end positions and tripping torques can be set using the display without opening the actuator.

10 Failure

In case of failure, the backlight colour of the display changes to red. The cause for failure can be requested via the display.

Actuators are expected to offer long service life, long maintenance intervals and straightforward maintenance procedures. These factors are important in contributing to reducing plant operation costs.

Consequently, emphasis was laid on integrating advanced diagnostic abilities for development enhancements of AUMA devices.

Maintenance - when required

Running times, switching frequency, torque, ambient temperature - impacts which vary from actuator to actuator requiring individual maintenance schedules for each device. These factors are continually recorded and assessed in the following four maintenance status categories: O-rings, lubricant, reversing contactors, and mechanics. The maintenance requirements are shown on the display as bar chart. When reaching a limit, the actuator signals the respective maintenance requirement. It is also possible to monitor specified intervals by means of a maintenance plan.

Out of specification - correct potential failure causes prior to occurrence

Plant operators receive anticipated information about potential problems. The signal indicates that the actuator is subjected to out of range operational conditions, for example excessive ambient temperatures which might lead to a failure in case of frequent and longer occurrence.

Plant Asset Management

If one of the two before mentioned signals are indicated, timely corrective actions can be introduced - the key to Plant Asset Management. Actions will be taken either by the service staff on site, or by AUMA service technicians, offering appropriate warranty on the basis of the repair or maintenance work.

AUMA service can propose maintenance agreements, and complete all required actions following signal indications.

RELIABILITY, SERVICE LIFE, MAINTENANCE - WITH TEST ENGINEERING FEATURES

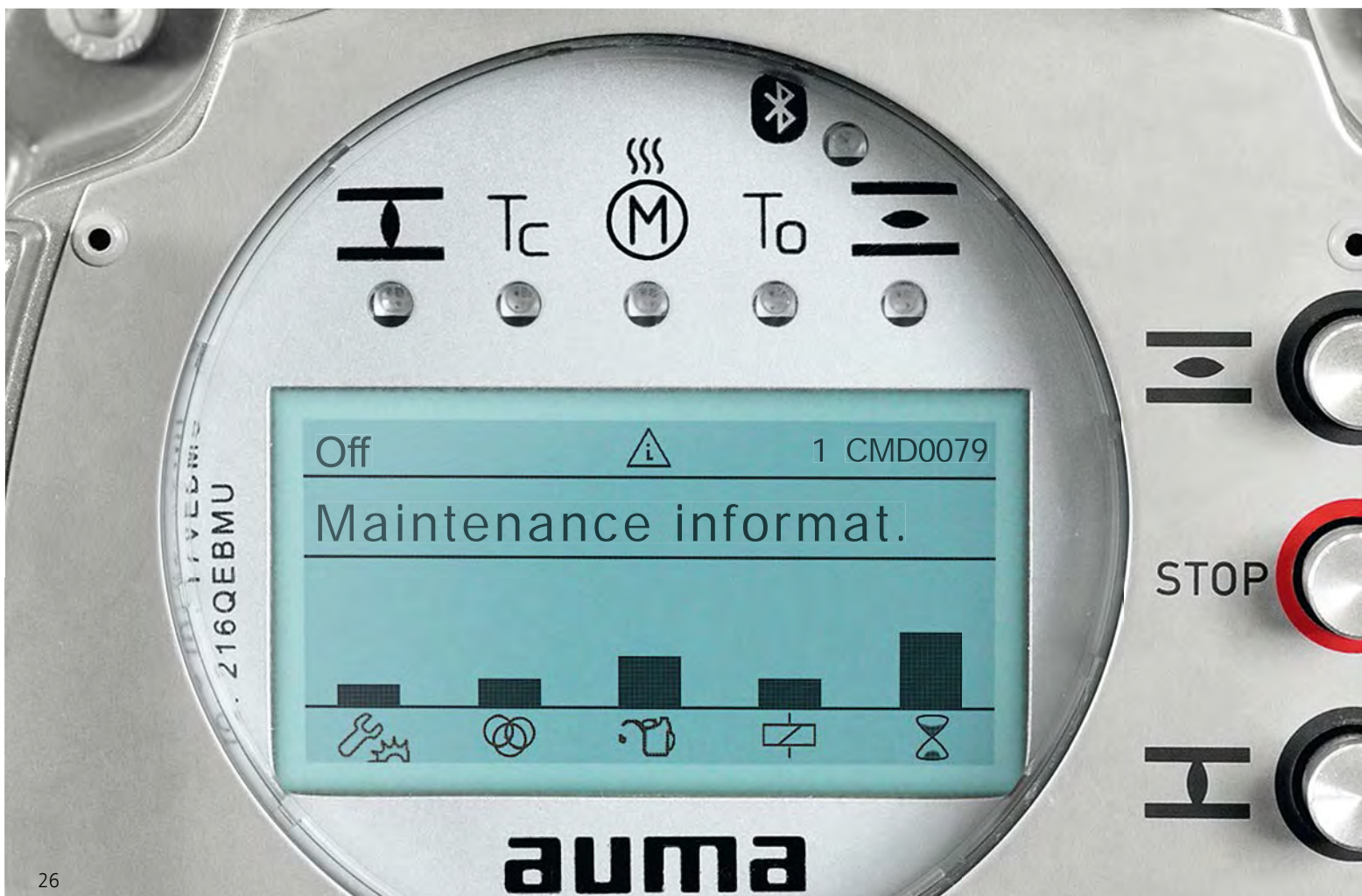

Time-stamped event report/ operating data logging

Setting procedures, switching procedures, warning signals, failures, and running times are recorded in the time-stamped event report. The event report is a distinct component of the diagnostic features of the AC.

Valve diagnostics

AC controls are capable of recording torque characteristics at different times. The comparison of data sets allows assessment of any changes in valve characteristics.

Assessment - easy to handle

NAMUR NE 107 with the easy and clear diagnostic classification supply valuable support for plant operators. Data relating to diagnostics can be requested via device display, via fieldbus or AUMA CDT (refer to page 30).

AUMA actuators with fieldbus interface also support standardised concepts for remote diagnostics from the control room (refer to page 39).

Diagnostic classification according to NAMUR NE 107

The objective of NAMUR NE 107 recommendation is to issue uniform and clear symbols and inform the operator about the device status.



Maintenance required

The actuator can still be controlled from the control room. The device must be inspected by a device specialist to avoid any unscheduled downtime.



Function check

Due to ongoing work on the actuator, the device cannot be controlled from the control room at that specific time.



Out of specification

Deviations from the permissible application conditions determined by the actuator itself through self-monitoring. The actuator can still be controlled from the control room.



Failure

Due to functional failures within the actuator or peripherals, the actuator might not be controlled from the control room.



AUMA CDT FOR AC CONTROLS - EASY COMMISSIONING

Any data can be requested and parameters changed via display and operating elements of the AC, without requiring further tools. This can be of crucial advantage in certain situations. Furthermore, AUMA CDT offers comfortable handling of device files.

This Commissioning and Diagnostic Tool (CDT) was specially developed for actuators with AC integral controls. Please refer to www.auma.com for free of charge download to laptop and PDA.

Connection to the actuator is established wireless via Bluetooth, it is password protected and encrypted.

Easy commissioning

The advantage of AUMA CDT is the clearly structured presentation of all device parameters. Tooltips are further valuable aids when defining the settings.

AUMA CDT allows to perform settings independently of the actuators, data saving and later data transmission to the device. Actuator settings can be transferred to another device via AUMA CDT.

Actuator data can be archived in the AUMA CDT database.

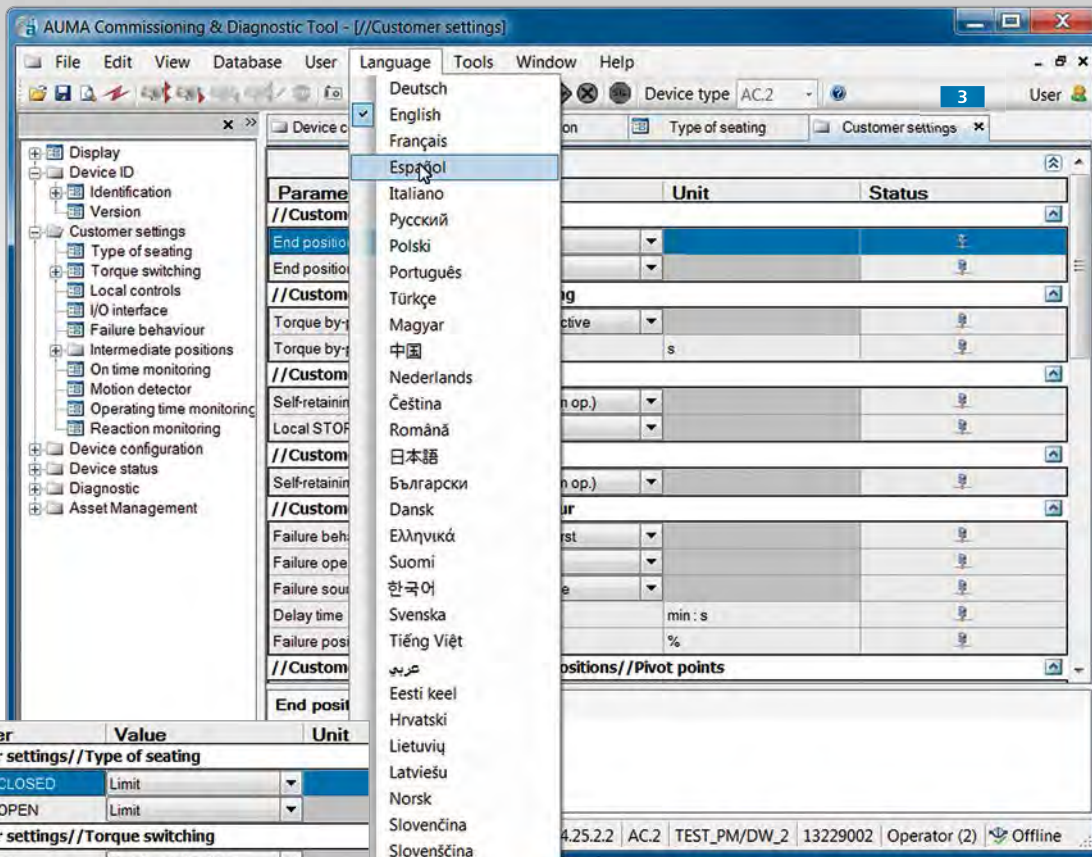

1

Parameter	Value	Unit
//Customer settings//Type of seating		
End position CLOSED	Limit	
End position OPEN	Limit	
//Customer settings//Torque switching		
Torque by-pass	Function not active	
Torque by-pass duration	0,0	s
//Customer settings//Local controls		
Self-retaining Local	Off (push-to-run op.)	
Local STOP	Off	
//Customer settings//I/O interface		
Self-retaining Remote	Off (push-to-run op.)	
//Customer settings//Failure behaviour		
Failure behaviour	Good signal first	
Failure operation	STOP	
Failure source	Active interface	
Delay time	00.03,0	min : s
Failure position	50,0	%
//Customer settings//Intermediate positions//Pivot points		
End position CLOSED	2	
Type of seating in end position CLOSED		
Default value: Limit		

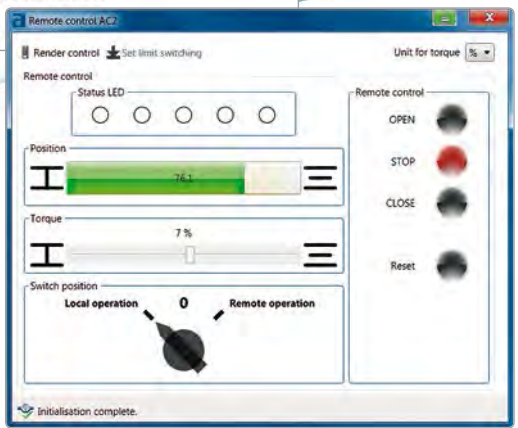

4

1 AUMA CDT - clear, multi-lingual, intuitive

CDT allows you to evaluate the precise condition before taking actions, the logic structure and parameter architecture are decisive. Text display is available in more than 30 languages. Completed and supported by tooltips **2**. They provide brief explanations and the default values for the selected parameters.

3 Password protection

The various password protected user levels prevent unauthorised modifications of device settings.

4 Remote control

The actuator is remotely driven via AUMA CDT. All signals of indication lights and all status signals available via AC display are clearly visible. It is also possible to access from a laptop and immediately observe the reactions on the actuator status.



AUMA CDT FOR AC CONTROLS - DIAGNOSTICS DIALOGUE

Collecting operational data or recording characteristics is required to improve field device operation with regard to their lifetimes. A further requirement is the useful evaluation of the data obtained.

AUMA CDT offers a certain number of evaluation criteria supporting correct data analysis. Communication between AUMA service and plant operators allow optimisation of device parameters or scheduling maintenance actions.

AUMA CDT - the information centre

Pertaining wiring diagram and matching data sheet - AUMA CDT downloads these documents directly from the AUMA server. Data records of actuators can be saved on the laptop and transmitted to AUMA service for assessment.

AC controls are capable of recording characteristics; AUMA CDT offers optimum visualisation via Live View. This supports device behaviour evaluation during service. AUMA CDT is equipped with functions for device history assessment in order to graphically process the chronologically saved events within the event report.

AUMA CDT supplies a total view on the actuators, the ideal prerequisite to correctly assess the actuator status and the immediate peripheral equipment.

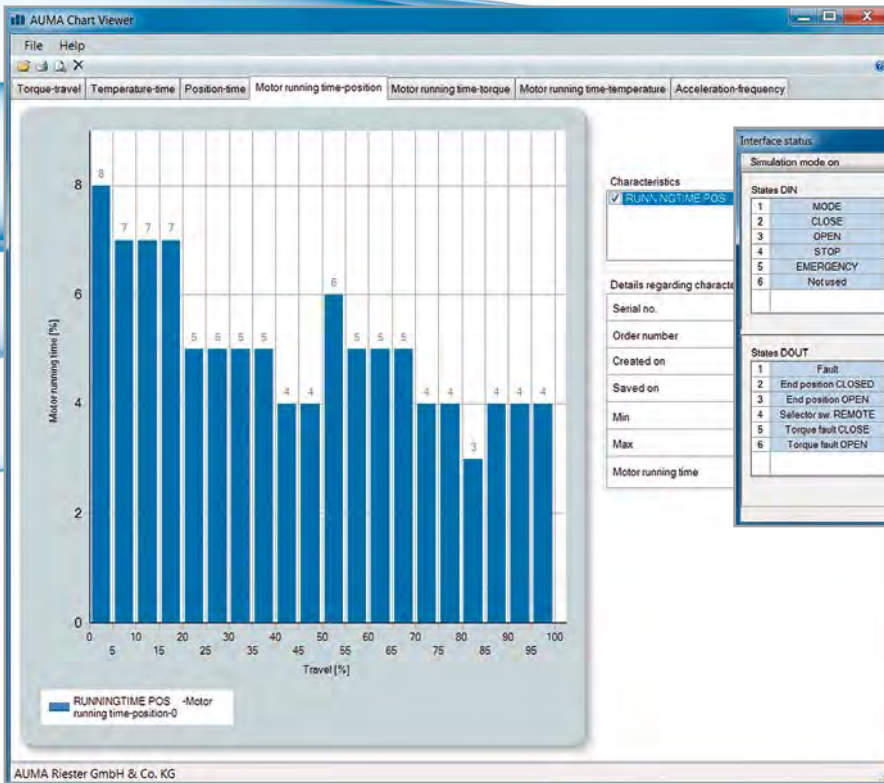

AUMA CDT as fieldbus master

Actuator function failure can be caused by a faulty communication with the control station. For parallel communication, signal paths between control room and actuator can be verified by means of a measuring device. Functional tests are also recommended for fieldbus applications.

AUMA CDT can be used as temporary fieldbus master. It can be used to verify whether the actuator correctly receives, processes, and responds to the fieldbus telegrams. If this is the case, the failure is not caused by the actuator.

Further use of AUMA CDT fieldbus master: The actuator can even be commissioned if communication to the DCS is not established or not possible, e.g. in an assembly workshop.

Examples of analysis tools

- > **1** The motor running time across valve position indicates whether the valve position is within expected range across the elapsed time period.
- > **2** The interface status window visualises which signals are present at the interface to the DCS.

3 AUMA Support App

You may also quickly and easily access the device documentation via the AUMA Support App. When scanning the Data Matrix code on the name plate via smartphone or tablet PC, the app allows request and download of operation instructions, wiring diagram, technical data sheet, and inspection certificate pertaining to an actuator from the AUMA server to your mobile device.

The AUMA Support App is available for free download: For Android-based devices in the Google Play Store, for Apple devices with iOS operating system in the Apple store. The QR code below leads you directly to the App. The respectively required version is automatically selected.



The mechanical interface to the valve is standardised. Interfaces to the control system undergo permanent development.

Parallel control, fieldbus, or both for reasons of redundancy? When opting for fieldbus, which protocol to use?

Irrespective of your decision on the interface, AUMA actuators can be equipped with the suitable interface to match all systems established within process control engineering.

Actuator commands and signals

In simple applications, operation commands OPEN and CLOSE, feedback signals End position OPEN/End position CLOSED reached as well as Collective fault signal suffice. Any isolating valve can be reliably operated with these five discrete signals.

However, if the valve position is to be controlled, further continuous signals are required: Position setpoint and position feedback signal (actual value), typically a 4 – 20 mA analogue signal for parallel communication.

Fieldbus protocols expand the bandwidth for information transmission. Further to transmission of commands and feedback signals required for operation, access to all device parameters and operating data via fieldbus from the DCS is made available.

COMMUNICATION - TAILOR-MADE INTERFACES



AM

All inputs and outputs are hard wired, as detailed on the terminal plan.

- > Three binary inputs for the control commands OPEN, STOP, CLOSE
- > Five binary outputs with the following functions: End position CLOSED, end position OPEN, selector switch in REMOTE, selector switch in LOCAL, collective fault signal
- > As an option, an analogue 0/4 – 20 mA output for remote position indication.

The binary inputs and outputs are potential-free, the analogue output is galvanically isolated.

AC

Signal assignment of outputs can be modified at a later date via AC device setting. Depending on the version, AC controls provide:

- > Up to six binary inputs
e.g. operation commands OPEN, STOP, CLOSE, enable signals for local controls, EMERGENCY commands, etc.
- > Up to ten binary outputs
e.g. for feedback of end positions, intermediate positions, selector switch position, failures, etc.
- > Up to two analogue inputs (0/4 – 20 mA)
e.g. for setpoint reception to control the positioner or PID controller
- > Up to two analogue outputs (0/4 – 20 mA)
e.g. for feedback of valve position or torque

The binary inputs and outputs are potential-free, analogue outputs are galvanically isolated.

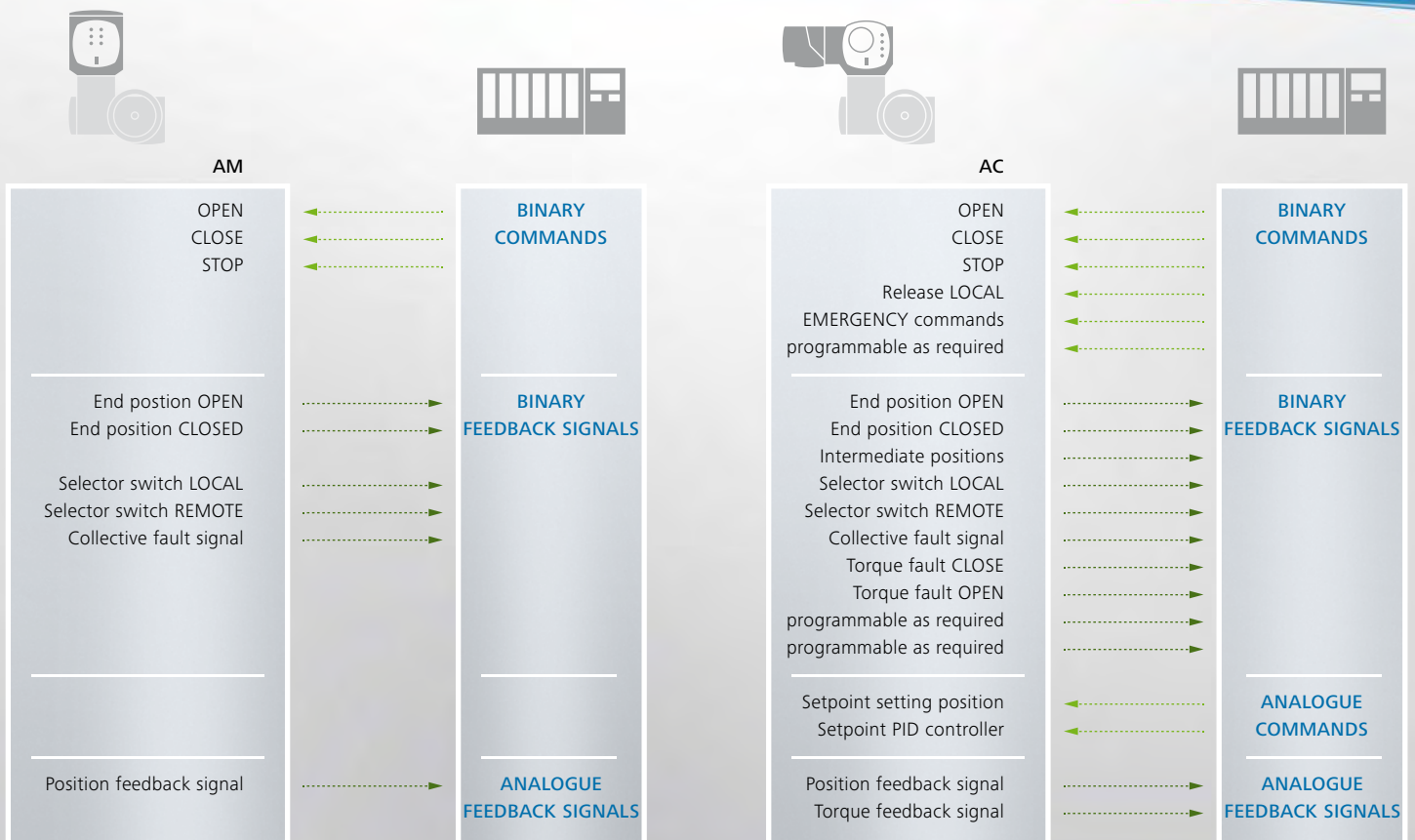

Cost reduction is one of the main factors in favour of fieldbus technology. In addition, introduction of serial communication in process automation has proven as an innovation driver for field devices and consequently for actuators. Concepts for efficiency gains such as remote parameterisation or Plant Asset Management would not be feasible without fieldbus technology. AUMA actuators equipped with fieldbus interfaces are state of the art.

AUMA fieldbus devices

Many different fieldbus systems are available on the market. Certain preferences have evolved on a regional level or specific to certain plant applications. Since AUMA actuators are implemented in all types of process plants around the globe, they are available with any fieldbus system established in this industry.

- > Profibus DP
- > Modbus RTU
- > Foundation Fieldbus
- > HART

Overall, AUMA devices are available with binary and analogue inputs to connect additional sensors to the fieldbus.

COMMUNICATION - FIELDBUS

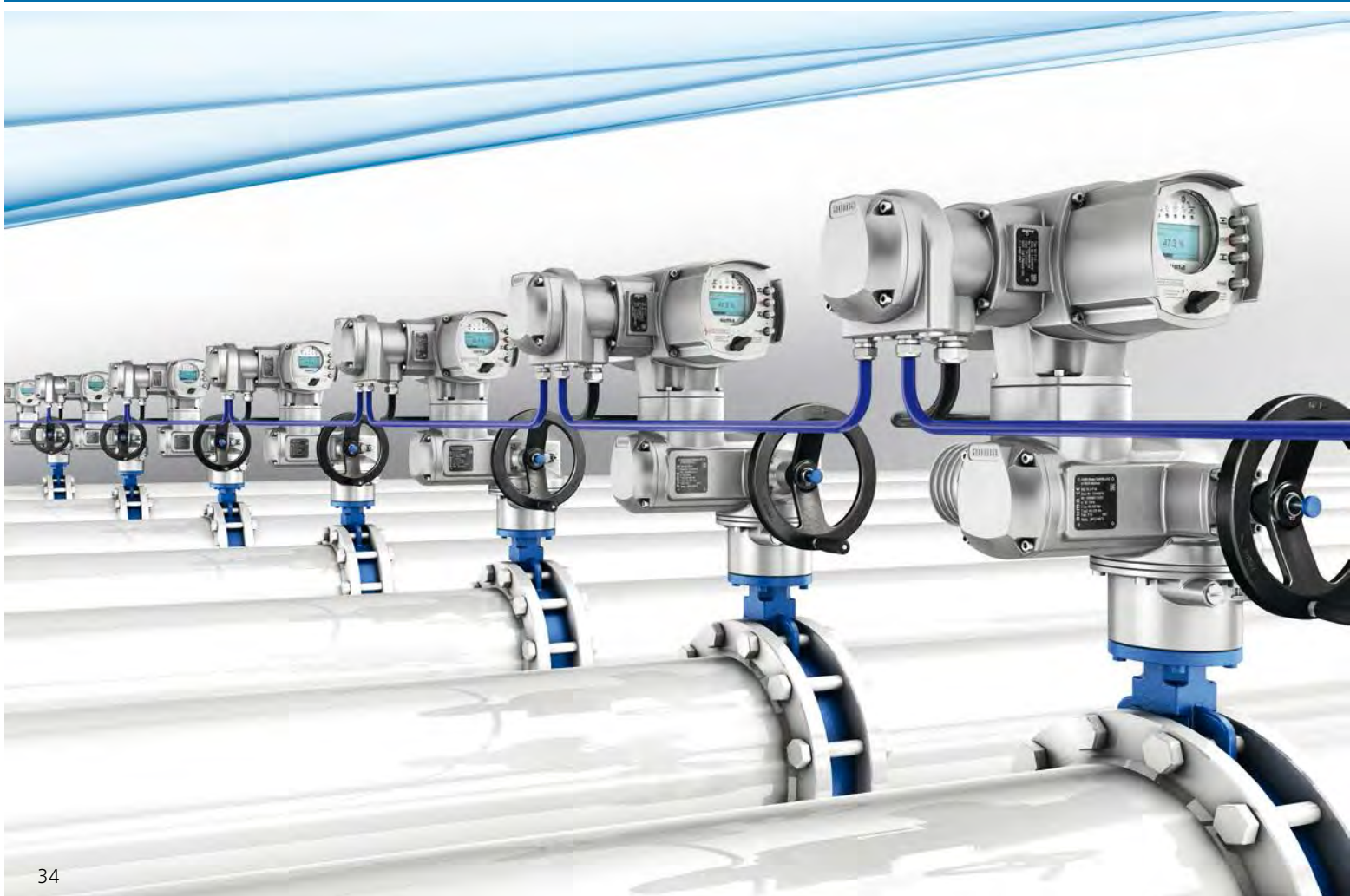

Profibus offers a complete family of fieldbus versions: Profibus PA for process automation, Profinet for data transmission based on Ethernet and Profibus DP for automating plants, power plants and machines. Due to its simple and robust physical layer (RS-485) and the different service levels DP-V0 (fast cyclic and deterministic data exchange), DP-V1 (acyclic access to device parameters and diagnostic data) as well as DP-V2 (further functions such as time stamp or redundancy), Profibus DP is the ideal solution for plant automation.

- > International standard, IEC 61158/61784 (CPF3), www.profibus.com
- > Large installation base
- > Standardised integration within the DCS (FDT, EDD)
- > Large selection of devices
- > Typical applications: Power plants, sewage treatment plants, water treatment plants, tank farms

AUMA actuators with Profibus DP

- > Support Profibus DP-V0, DP-V1 and DP-V2
- > High speed data exchange (up to 1.5 Mbit/s - corresponds to approx. 0.3 ms/actuator)
- > Integration within the DCS via FDT or EDD (please also refer to page 39)
- > Cable length up to approx. 10 km (without repeater up to 1,200 m)
- > Up to 126 devices can be connected
- > Option: Redundant line topology as an
- > Option: Data transmission via fibre optic cables (refer to page 43)
- > Option: Overvoltage protection up to 4 kV

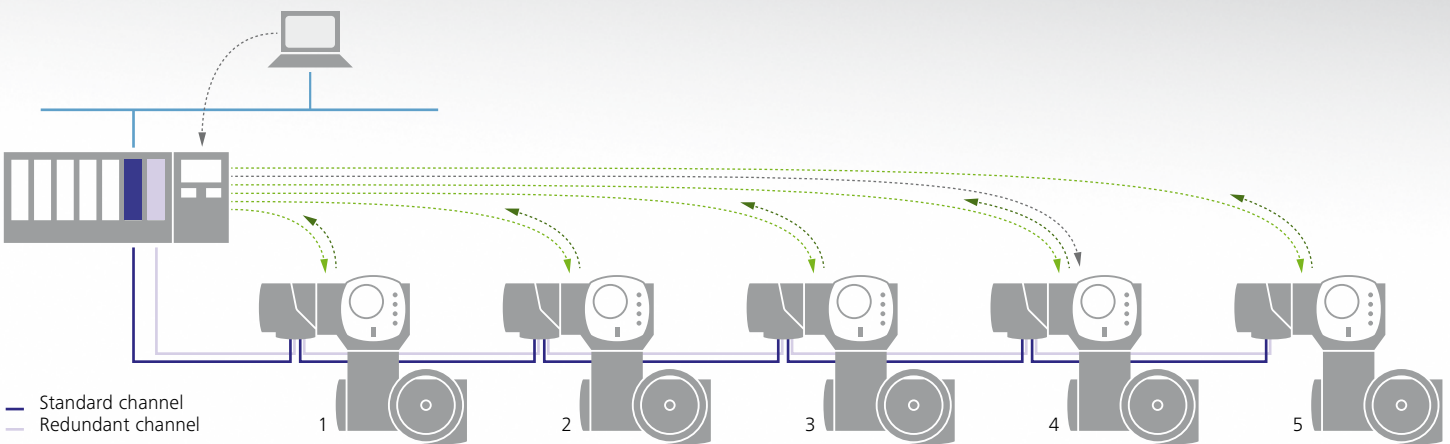

Bus cycle with 5 actuators

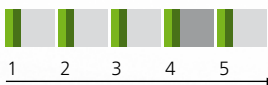

- Cyclic process data request from master
- Cyclic process data feedback from slave
- Acyclic diagnostic or parameter data transmission

Comparison of bus cycle times

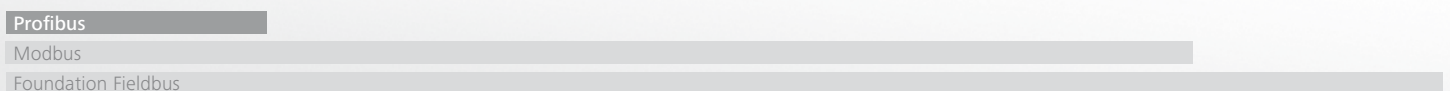

In comparison with other fieldbus technologies, Modbus is simple but has a multi-functional fieldbus protocol. It offers all services required for plant automation, e.g. exchange of simple, binary information, analogue values, device parameters or diagnostic data.

For plant automation and similar to Profibus, the simple and robust physical layer RS-485 is often used.

On the basis of this physical layer, Modbus supports various telegram formats, e.g. Modbus RTU or Modbus ASCII. Using the Modbus TCP/IP version based on Ethernet, vertical integration into a host automation system is often implemented.

- > International standard, IEC 61158/61784 (CPF15), www.modbus.org
- > Simple protocol
- > Worldwide distribution
- > Largely sufficient for many simple automation tasks
- > Typical applications: Water and wastewater treatment plants, pumping stations, tank farms

AUMA actuators and Modbus RTU

- > Fast data exchange (up to 115.2 kbit/s - corresponds to approx. 20 ms/actuator)
- > Cable length up to approx. 10 km (without repeater up to 1,200 m)
- > Up to 247 devices can be connected
- > Option: Redundant line topology
- > Option: Data transmission via fibre optic cables (refer to page 43)
- > Option: Overvoltage protection up to 4 kV

COMMUNICATION - FIELDBUS

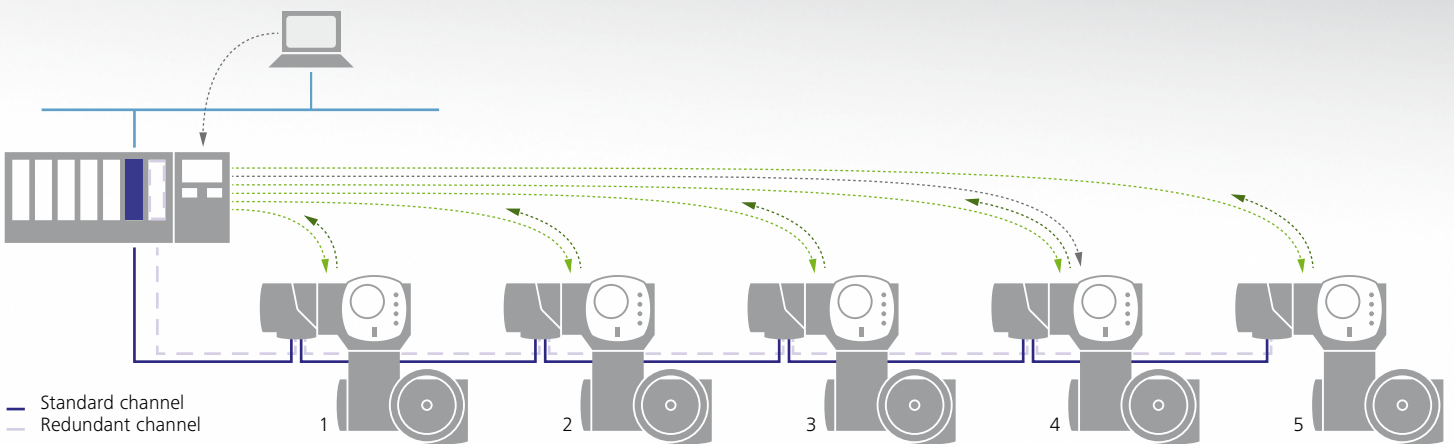

Bus cycle with 5 actuators



- Cyclic process data request from master
- Cyclic process data feedback from slave
- Acyclic diagnostic or parameter data transmission

Comparison of bus cycle times

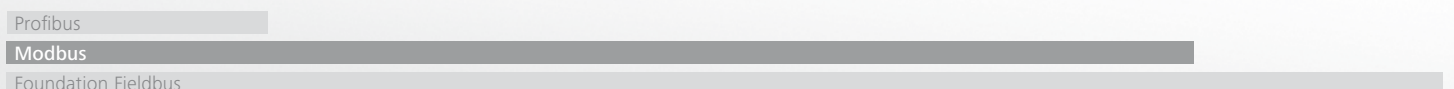

Foundation Fieldbus (FF) was explicitly adapted to the requirements of process automation. Transmission physics of the FF H1 protocol used at field level are based on IEC 61158-2 and ISA SP 50.02. These standards define the framework for data transmission and energy supply of simple field devices using the same cable pair. FF H1 supports various topologies. In combination with junction boxes or segment barriers, extremely flexible cable installations are possible. Apart from conventional line and tree structures, FF H1 supports point-to-point topology or other structures with one trunk combined with individual spurs leading to the field devices.

Foundation Fieldbus data interfaces are based on standardised function blocks, for example AI (Analog Input), or AO (Analog Output) whereby their inputs and outputs can be linked. Therefore, FF fieldbus devices can directly communicate with each other provided that the segment is equipped with a Link Active Scheduler (LAS) to coordinate FF communication.

AUMA actuators and Foundation Fieldbus

AUMA actuators support FF H1 version.

- > Data exchange at 31.25 kbit/s, typical cycle time 1s
- > Cable length up to approx. 9.5 km (without repeater up to 1,900 m)
- > Up to 240 devices can be addressed, typically 12 to 16 field devices are available
- > Integration within the DCS via DD or FDT (please also refer to page 39)
- > AUMA actuators support LAS and thus adopt the tasks of the link active scheduler.
- > Option: Overvoltage protection up to 4 kV

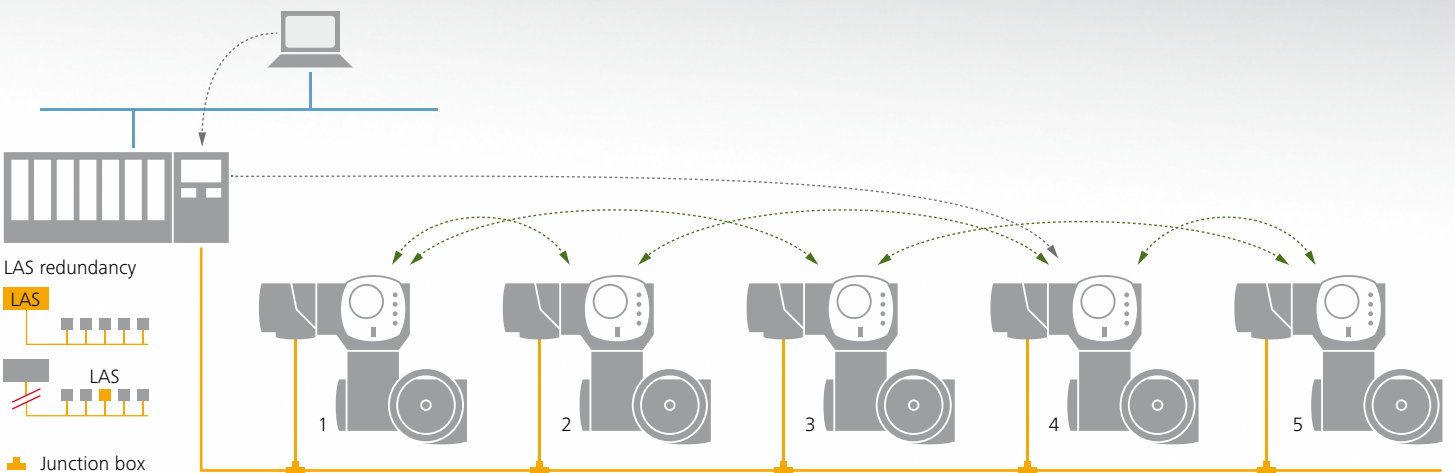

Bus cycle with 5 actuators



■ : Cyclic data exchange between process participants (publisher <=> subscriber)
 ■ : Acyclic diagnostics or parameter data transmission (report distribution, client server)

Comparison of bus cycle times

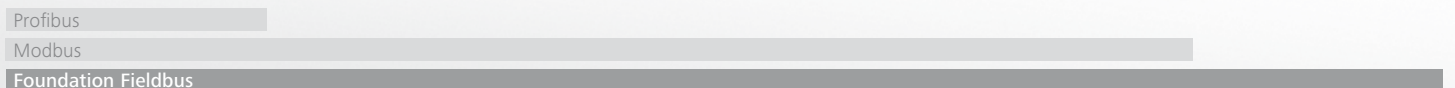

HART makes use of the known 4 – 20 mA standard signal for analogue data transmission. HART communication is modulated as additional signal to the analogue signal. Advantages: Simultaneous transmission of the digital and the analogue HART signals. Existing 4– 20 mA infrastructure is also available for digital communication. Facilitates reading additional parameter and diagnostic data from field devices.

HART uses the master-slave principle and offers various commands for data transmission. Normally, the conventional 4 – 20 mA point-to-point wiring is used.

- > International standard IEC 61158/61784 (CPF9)
- > Worldwide distribution
- > Large installation base
- > Standardised integration within the DCS (FDT, EDD)
- > Large selection of devices

AUMA actuators with HART

- > 4 – 20 mA HART analogue signal either for setpoint transmission or alternatively to communicate the actual position.
- > Transmission of parameter and diagnostic data via digital HART communication
- > approx. 500 ms per actuator for digital communication
- > Integration within the DCS via EDDL (please also refer to page 39)
- > Length of cable approx. 3 km

COMMUNICATION - HART

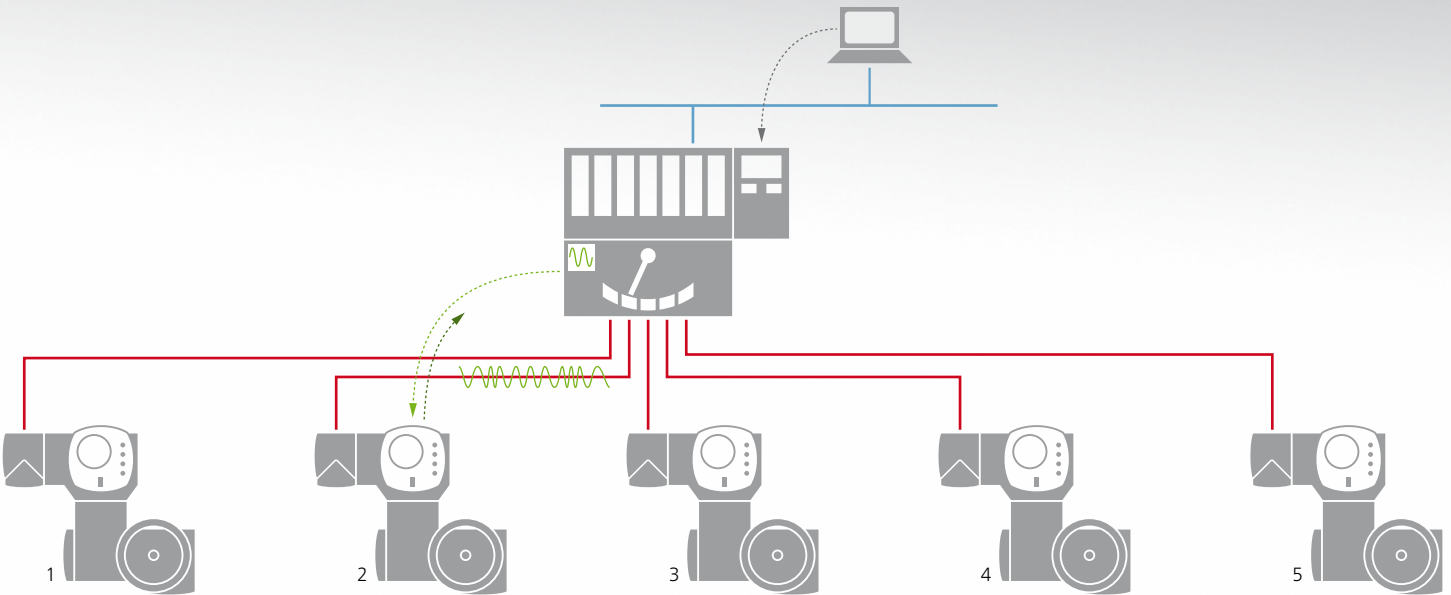

— Conventional 4 – 20 mA signal cable
 ~ Digital HART communication

Cycle with 5 actuators

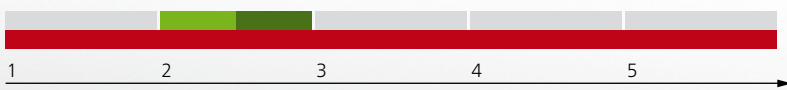

■ Parameter or diagnostic data request from master
 ■ Parameter or diagnostic data feedback from slave
 ■ Analogue process signal

EDD and FDT/DTM are two independent technologies for harmonisation of device integration within fieldbus systems across all field devices. This includes for example device configuration, device replacement, fault analysis, device diagnostics, or documentation of these actions. For this reason, EDD and FDT/DTM are crucial for Plant Asset Management and Lifecycle Management of a plant.

Besides the imperative main functions, field devices possess diagnostic functions and many specialised application functions to adapt the device to the process and environmental conditions as required. If certain prerequisites are fulfilled, e.g. DP-V1 protocol for Profibus, data exchange connected to these functions can directly take place between control station and field device via fieldbus. For AUMA actuators, this further includes status and diagnostic signals in compliance with NAMUR NE 107, parameter modifications of user functions, information of the electronic device ID or operational data for preventive maintenance.

EDD or FDT/DTM is used to harmonise access from the control station to the data available with the various field devices.

EDD

Each field device supporting this technology is provided with an EDD (Electronic Device Description). This file combines device parameters described in ASCII using standardised and platform neutral EDD language. The technology helps to create a uniform user philosophy with identical parameter visualisation across all field devices.

FDT/DTM

FDT (Field Device Tool) is a software interface definition to integrate DTM (Device Type Manager) into the FDT system of the maintenance processor. DTM is a software module supplied by field device manufacturers. Similar to a printer driver, DTM is installed within the FDT frame application to visualise settings and information available from the field devices.

You may download available EDDs and DTMs for AUMA actuators at: www.auma.com.

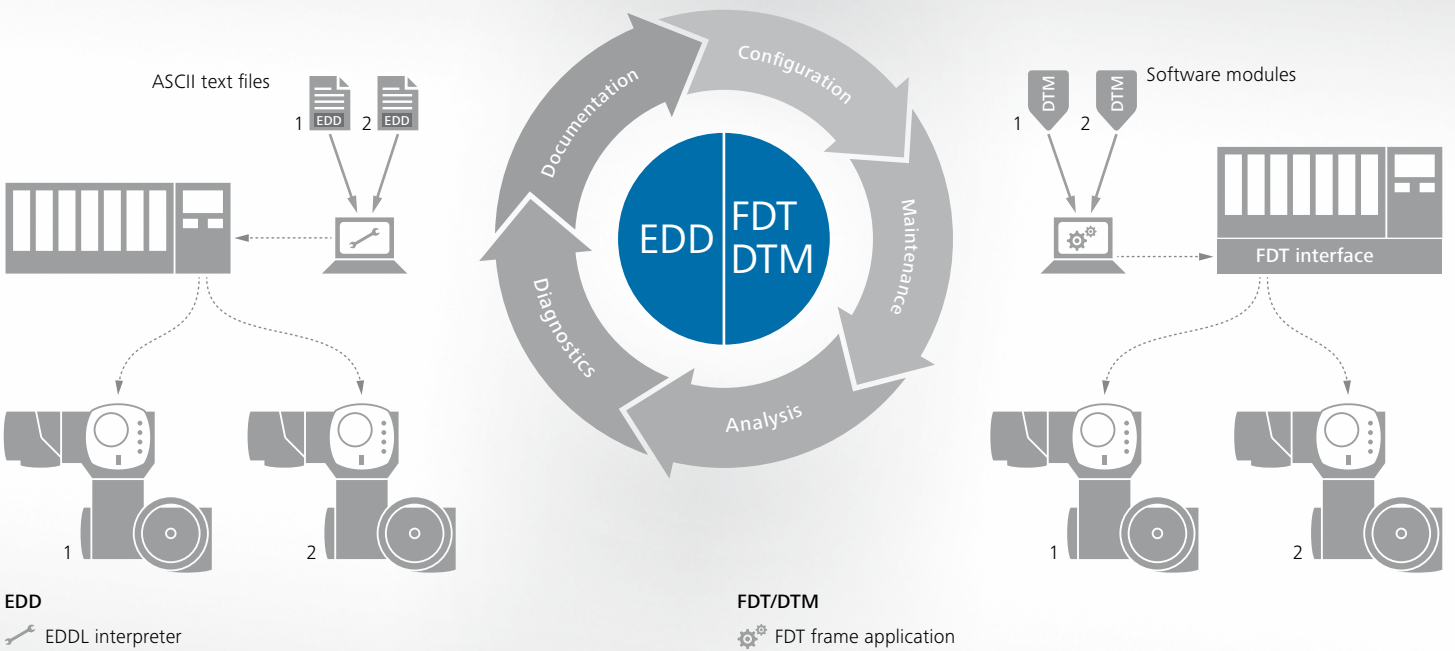

EDD
 EDDL interpreter

FDT/DTM
 FDT frame application

Comparison of functional scope

EDD	
FDT/DTM	



SIMA - THE FIELDBUS SYSTEM SOLUTION

SIMA is the ideal master station for perfect integration of actuators into a DCS. Entire communication is based on open fieldbus protocols.

- > SIMA supports the user with a mostly automated procedure for commissioning the connected actuator network, irrespective of the DCS - plug and play.
- > SIMA manages communication to field devices including all redundant data channels and hot standby components.
- > SIMA as data concentrator collects all actuator status signals and sends the signals relevant for normal service to the DCS.
- > SIMA facilitates status information access to the connected actuators.
- > In the event of failures, SIMA supports fast fault identification and remedy.
- > SIMA serves the purpose of gateway to adapt fieldbus communication with actuators to the available interfaces of the DCS.

Configuration interface

Various SIMA equipment features offer different access options for operation and configuration. This includes an integrated touch screen, connection facilities for a mouse, keyboard and external screen or Ethernet interface for SIMA integration into an available network.

Graphic elements provide overall system visualisation at a glance. Settings and configurations are password protected for different user levels.

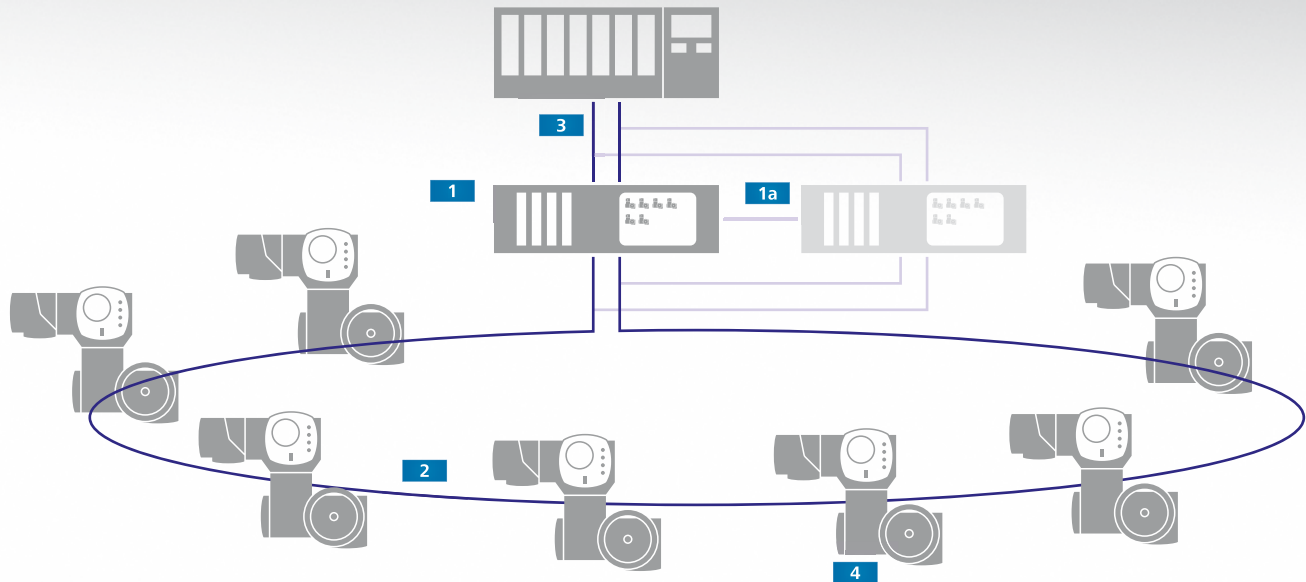

Redundancy within loop

Communication without fault Communication in the event of fault



Comparison of max. cable lengths of fieldbus systems

without SIMA 10 km

with SIMA

296 km

1 SIMA Master Station

SIMA combines standardised industrial PC components extended by required fieldbus interfaces. The entire hardware is housed in a robust 19" industrial enclosure with EMC protection.

1a Hot standby SIMA

Increased availability and reliability can be achieved by installing a backup SIMA, taking over all tasks of the primary SIMA in case of failure.

2 Redundant Modbus loop

The major advantage of this topology is the integrated redundancy. If the loop is interrupted, SIMA considers both segments as separate lines and all actuators remain accessible. Actuators selected for this topology are equipped with a repeater function for galvanic isolation of loop segments and for Modbus signal amplification. As a consequence, a total length of up to 296 km can be achieved using a conventional RS-485 cable with maximum 247 participants.

It is also possible to implement line topologies with SIMA.

3 Communication with DCS

DCS communication is possible using Modbus RTU or Modbus TCP/IP.

4 AUMA actuators

AUMA actuators are equipped with the suitable interface matching selected fieldbus protocol and topology. Individual devices can be separated from the fieldbus without interrupting fieldbus communication to other devices.

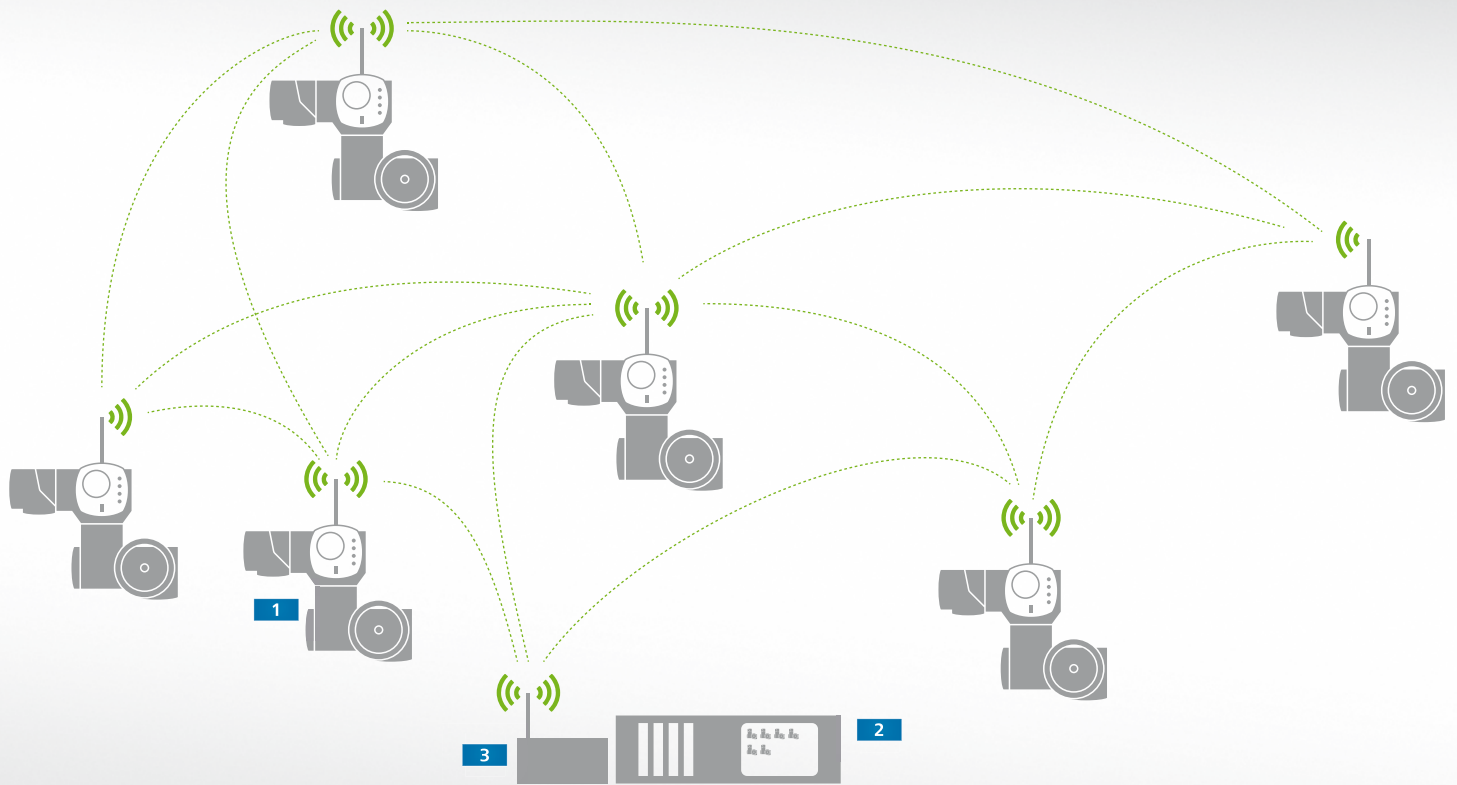

ALTERNATIVE COMMUNICATION CHANNELS - WIRELESS AND FIBRE OPTIC CABLES

The use of copper cables can be unsatisfactory for certain applications. Here, it is possible to switch to fibre optic cables. When selecting Wireless, communication is made without cables.

WIRELESS

Further advantages other than obsolete wiring: Fast commissioning and easy system extension. Each participant can communicate within the own radio range. This mesh topology increases availability through redundant communication. If one participant or a radio connection fails, an alternative communication path is automatically adopted.

The Wireless solutions is a variant of the SIMA system solution, enhancing to a large extent of the functions as mentioned on page 40.

Radio transmission is based on wireless communication standard IEEE 802.15.4 (at 2.4 GHz). AES-128-bit encryption is used to protect data transfer and parameterisation of field devices for communication.

1 AUMA actuators with Wireless interface

2 SIMA Master Station

SIMA described on page 40 coordinates communication to the field devices in cooperation with the gateway.

3 Wireless gateway

The gateway establishes access to the SIMA Wireless system and comprises the network manager and the security manager.

Application examples



Tunnel fire protection



Sewage treatment plant lightning protection

Comparison of max. distances between bus participants

Copper cable	1.2 km
FO multi-mode	2.6 km
FO single-mode	15 km

DATA TRANSMISSION VIA FIBRE OPTIC CABLES

Long distances between the devices combined with the high demands for data transmission security - in this instance, fibre optic cables (FO) are a suited transmission medium.

Long distances

Low attenuation of light signals in fibre optic cables allows coverage of long distances between participants, resulting in a considerably higher total fieldbus system length. When using multi-mode fibres, distances can reach up to 2.6 km between the devices. For single-mode fibres, this can still be up to 15 km.

Integral overvoltage protection

Contrary to copper cables, fibre optic cables are resistant to electromagnetic interference. Separated installation of signal cables and power cables is no longer required. Fibre optic cables provide galvanic isolation between actuators. This offers particular protection against overvoltages, for example in the event of lightning.

AUMA actuators with fibre optic interface (FO)

FO module for converting actuator-internal electrical signals into fibre optic signals is integrated within the electrical connection of the actuator. Connection of fibre optic cables is made via conventional FSMA plug/socket connectors.

In combination with Modbus RTU, FO cable systems in both line and star topology can be implemented. When using Profibus DP, ring topology is also possible. In this case, the availability of the fibre optic ring is monitored. If the ring is interrupted, a warning will be sent. This warning is integrated within the signalling pattern of AC actuator controls, visualised on the display and transmitted to the control station in compliance with the specified signalling pattern.



AC

SA





AM



SQ



SA multi-turn actuator and SQ part-turn actuator

The basic actuator consists of the following components: motor, worm gearing, control unit, handwheel for emergency operation, electrical connection and valve attachment.

For actuators with this type of basic equipment, operation commands and feedback signals can be processed by means of external controls provided with switchgear and the pertaining logic.

Typically, AUMA actuators are supplied with AM or AC integral controls. Due to the modular design principle, the controls are connected to the actuator via a simple plug/socket connection.

Differences between SA and SQ actuators

The output shaft **1a** of SA multi-turn actuators is a hollow shaft to allow the stem to pass through the actuator should the valve be equipped with a rising valve stem.

SQ part-turn actuators are equipped with mechanical end stops **1b** for swing angle limitation to make sure that valve end positions can be precisely approached during manual operation. Part-turn actuators are available with various swing angle ranges. Please also refer to page 67.

2 Motor

Use of 3-phase, 1-phase AC and DC motors with high starting torques - specifically developed for valve automation. Thermal protection is ensured by thermostats or PTC thermistors.

A dog coupling for torque transmission and an internal motor plug/socket connector allow for fast replacement. For further information, please refer to page 70.



Control unit

Determining the valve position and setting the valve end positions/torque monitoring to protect the valve against overload. Depending on customer specifications, a control unit is installed either as electromechanical or electronic version.

3a Control unit - electromechanical version

Travel and torque are mechanically sensed; switches are operated when reaching the tripping points. The tripping points for both end positions and the tripping torques for both directions are mechanically set.

As an option, the valve position can be transmitted as continuous signal to the control room.

The electromechanical control unit is needed if the actuator is supplied without integral controls. The unit can be combined with both AUMA controls types: AM and AC.

3b Control unit - electronic version

High-resolution magnetic transmitters convert valve position and applied torque into electronic signals. End position and torque settings during commissioning are performed at AC controls without opening the enclosure. Valve position and torque are transmitted as continuous signal.

The electronic control unit comprises sensors to record the torque changes, vibration and device temperature. AC controls time stamp and analyse this data, serving as basis for preventive maintenance schedules (please also refer to page 26).

For further information, please refer to pages 51 and 68.

4 Valve attachment

Standardised in compliance with EN ISO 5210 or DIN 3210 for SA multi-turn actuators, complying to EN ISO 5211 for SQ part-turn actuators. All output drive types are available in a multitude of variants. Please also refer to page 52.

AC

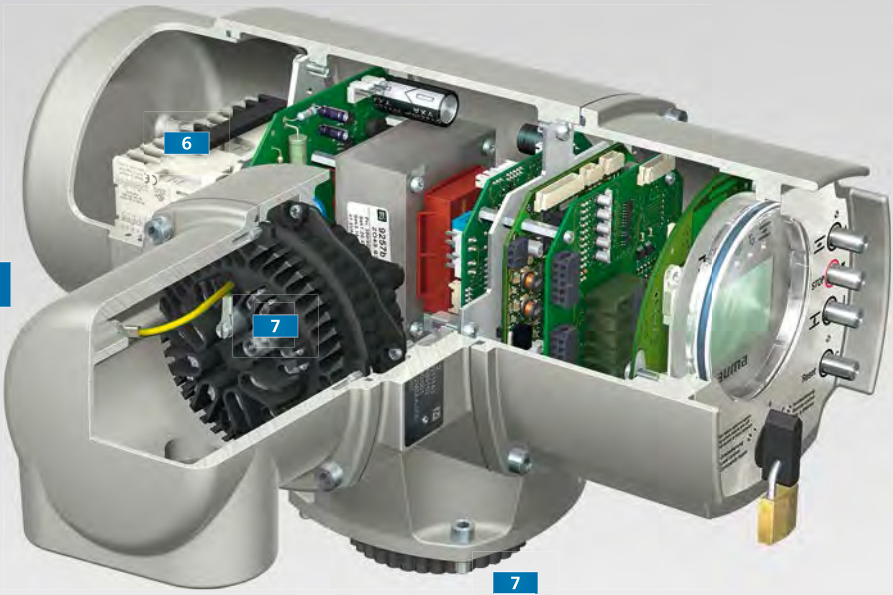

AM

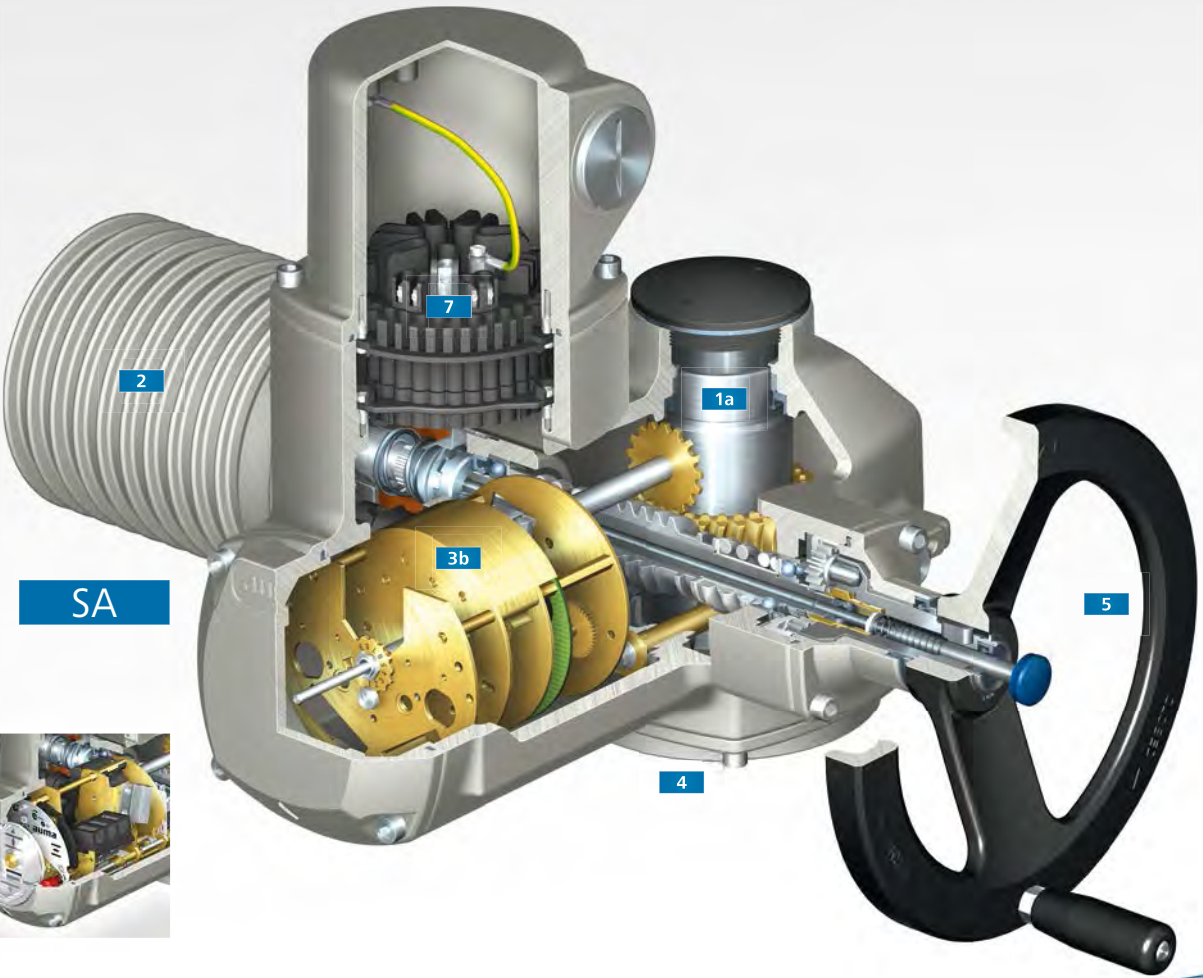

SA

Integral controls

Actuators equipped with AM or AC integral controls can be electrically driven via local controls as soon as the electrical power supply is connected. Actuator controls contain switch-gears, power supply units and interfaces to the DCS. They can process operation commands and feedback signals from the actuator.

Electrical connection between integral controls and the actuator is made by using a quick release plug/socket connector.

For further information on controls, please refer to pages 20 and 72 and respectively the following pages.

AM

Controls comprising simple logic to process limit and torque signals as well as the control commands OPEN, STOP, CLOSE. Three indication lights at local controls indicate the actuator status.

AC

Microprocessor based controls with comprehensive functionality and configurable interface. A graphic display indicates actuator status in more than 30 languages. When combined with the electronic control unit **3b**, all settings can be performed without opening the housing. Programming via menu navigation is made directly at the device or wireless via Bluetooth using the AUMA CDT.

AC controls are ideal for challenging actuator integration into complex control systems. Supporting Plant Asset Management.

AC controls are equipped with a further sensor for continuous temperature measurement within the framework of the preventive maintenance schedule.



6 Switchgear

In standard version, reversing contactors are used to switch the motor on or off. If modulating actuators are expected to perform a high number of starts, we recommend using thyristor units not subject to wear (also refer to page 72).

7 Plug-in electrical connection

Identical principle for all actuator configurations, irrespective whether integral controls are available or not. During maintenance work, the wiring remains undisturbed; electrical connections can be quickly separated and reconnected.

This reduces downtimes and avoids wiring faults at the time of reconnection (please also refer to pages 54 and 71).

AC controls are equipped with an easily accessible fuse holder within the electrical connection containing the short-circuit fuses for the transformer's primary windings.



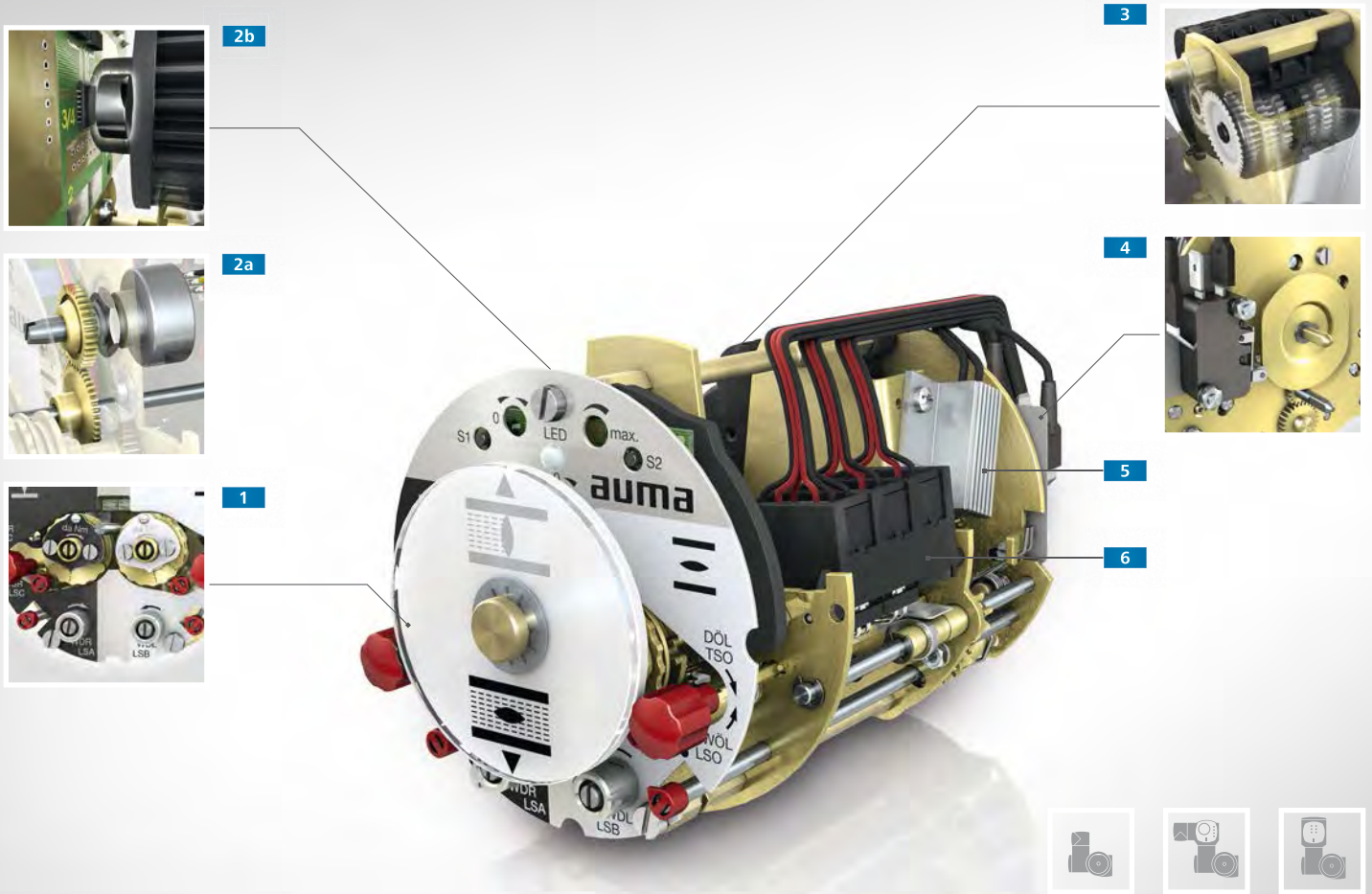

ELECTROMECHANICAL CONTROL UNIT

The control unit contains a sensor system for automatic actuator switch-off once the end position is reached. For this version, end position and torque recording are on mechanical basis.

1 Setting limit and torque switches

After removal of the housing cover and the mechanical position indicator, all setting elements are freely accessible (also refer to page 68).

2 Remote position transmitter

Valve position can be signalled to the DCS via the potentiometer [2a](#) or a 4 – 20 mA signal (via EWG/RWG) (please also refer to page 69). Valve position detection by the EWG [2b](#) is made contactless and consequently avoids wear.

3 Reduction gearing

The reduction gearing is required to reduce the valve stroke to the recording range of the remote position transmitter and the mechanical position indicator.

4 Blinker transmitter for running indication

Throughout travel, the segment washer operates the blinker switch (please also refer to page 68).

5 Heater

The heater minimises condensation within the switch compartment (also refer to page 71).

6 Limit and torque switches

The respective contact is operated when reaching an end position or exceeding a tripping torque.

In the basic version, one limit switch each is available for end positions OPEN and CLOSED and one torque switch for directions OPEN and CLOSE (also refer to page 68). For switching two different potentials, tandem switches with two galvanically isolated compartments can be integrated.

Intermediate position switches

As an option, intermediate switches can be installed for each direction to set one further switching point for each direction, as required.

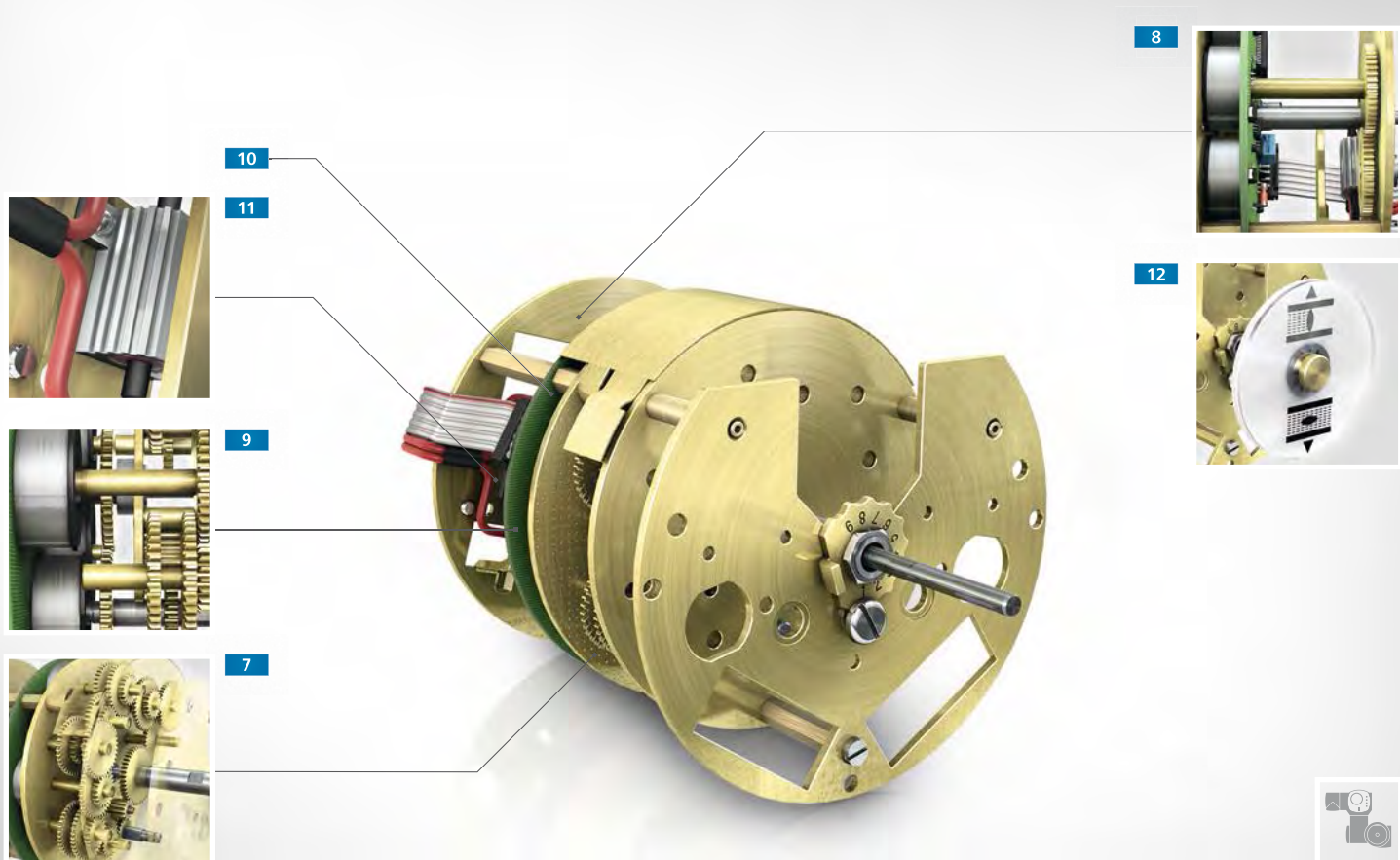

ELECTRONIC CONTROL UNIT

Non-Intrusive - without requiring any tools or opening the device - all settings are made externally if equipped with an electronic control unit (MWG) and AC integral controls.

7 Absolute encoder - Limit

Positions of magnets in the four gear stages correspond to the valve position. This type of limit sensing identifies valve position changes even in case of power failure. Consequently, battery backup is not required.

8 Absolute encoder - Torque

Magnet position senses the torque applied at valve flange.

9 Electronic recording of limit and torque

Hall sensors permanently sense magnet positions for limit and torque recording within the absolute encoders. A continuous limit and torque signal is generated by the integral electronics. The magnetic functional principle is robust and resistant against electromagnetic interference.

End position and torque settings are saved in the electronic control unit. These settings are still available and valid even when replacing AC controls.

10 Vibration and temperature sensors

The electronic board houses a vibration and temperature sensor for continuous temperature measurement. Data is evaluated using internal diagnostic functions.

11 Heater

The heater minimises condensation within the switch compartment (also refer to page 71).

12 Mechanical position indicator

Optional position indication disc identifies valve position even without power supply during manual actuator operation.

Switch for SIL version (not shown)

If the electronic control unit is used in an actuator in SIL version (refer to page 64), additional limit switches are installed in the control unit.

On demand of the safety function, the switches trip when reaching the end position and the motor is switched off.



SA



VALVE ATTACHMENT



The mechanical interface to the valve is standardised. For multi-turn actuators, flange dimensions and output drive types comply with EN ISO 5210 or DIN 3210.

1 Flange and hollow shaft

The hollow shaft transmits the torque via internal splines to the output drive plug sleeve. In accordance with EN ISO 5210, the valve attachment is equipped with a pilot.

1a Output drive plug sleeve with splines

The output drive plug sleeve solution allows for flexible adaptation to all output drive types. For output drive types **B1, B2, B3 or B4**, the plug sleeve is provided with appropriate holes. If one of the output drive types as described below is used, the output drive plug sleeve acts as connecting piece.

1b Output drive type A

Stem nut for rising, non-rotating valve stems. The mounting flange together with the stem nut and axial bearings form a unit, which is suitable for accepting thrust.

1c Output drive type IB

Integral laminated fabric components provide electric isolation between actuator and valve. This output drive type is used for pipelines with cathodic corrosion protection. The torque is transmitted to the valve by means of a so-called output drive sleeve described in section **1a**.

1d Output drive type AF

Similar to type A, this stem nut is additionally spring-loaded. The springs compensate for dynamic axial forces when operating at high speeds and even for thermal expansion of the valve stem.

Output drive type AK (not shown)

Similar to type A with pendulum stem nut for compensating deviations of valve stem. Corresponds to type AF with regard to appearance and dimension.

2 Anti-backdrive device (LMS)

To be used when self-locking is essential e.g. for high-speed actuators. The anti-backdrive device inhibits any valve displacement in case external forces act upon the closing element. This way, the use of brake motors is not required. The unit is mounted between actuator and valve.



SQ

3



3



3a



3b



3c



3d



For part-turn actuators, connection to the valve has to comply with EN ISO 5211. Like for the output drive plug sleeve for SA multi-turn actuators, SQ actuators provide a splined coupling for torque transmission.

3 Flange and output shaft

The output shaft transmits the torque via internal splines to the coupling. The flange can be equipped with a spigot in accordance with EN ISO 5211.

3a Coupling unbores

Standard version. Finish machining is made at the valve manufacturer's or on site.

3b Square bore

In compliance with EN ISO 5211. For special dimensions, please contact AUMA.

3c Bore with two-flats

In compliance with EN ISO 5211. For special dimensions, please contact AUMA.

3d Bore with keyway

The bore according to EN ISO 5211 can be supplied with one, two, three, or four keyways. The keyways conform to DIN 6885 Part 1. For keyways with other dimensions, please contact AUMA.

Extended coupling (not shown)

For special valve designs, e.g. recessed stem or if an intermediate flange is required between gearbox and valve.



ELECTRICAL CONNECTION

The plug-in electrical connector is a key element of the modular actuator design. The connector is a separate unit. The different connection types are compatible throughout all type ranges and can be used for actuators with or without integral controls.

During maintenance work, the wiring remains undisturbed; electrical connections can be quickly separated and reconnected. This reduces downtimes and avoids wiring faults when reconnecting.

1 AUMA plug/socket connector

The 50 contact AUMA plug/socket connector is the core element for all connection types. Incorrect connection is prevented by special code pins. The AUMA plug/socket connector also forms the electrical connection between actuator and integral actuator controls. Integral controls can be quickly removed from and reconnected to the actuator.

2 Cover for electrical connection S

With three cable entries.

3 Cover for electrical connection SH

With additional cable entries, offers 75 % more space than standard version.

4 Intermediate frame DS for double sealing

Preserves the enclosure protection even if the electrical connection is removed and prevents ingress of dirt or humidity into the housing. Can be combined with any electrical connection type and is easily retrofitted.

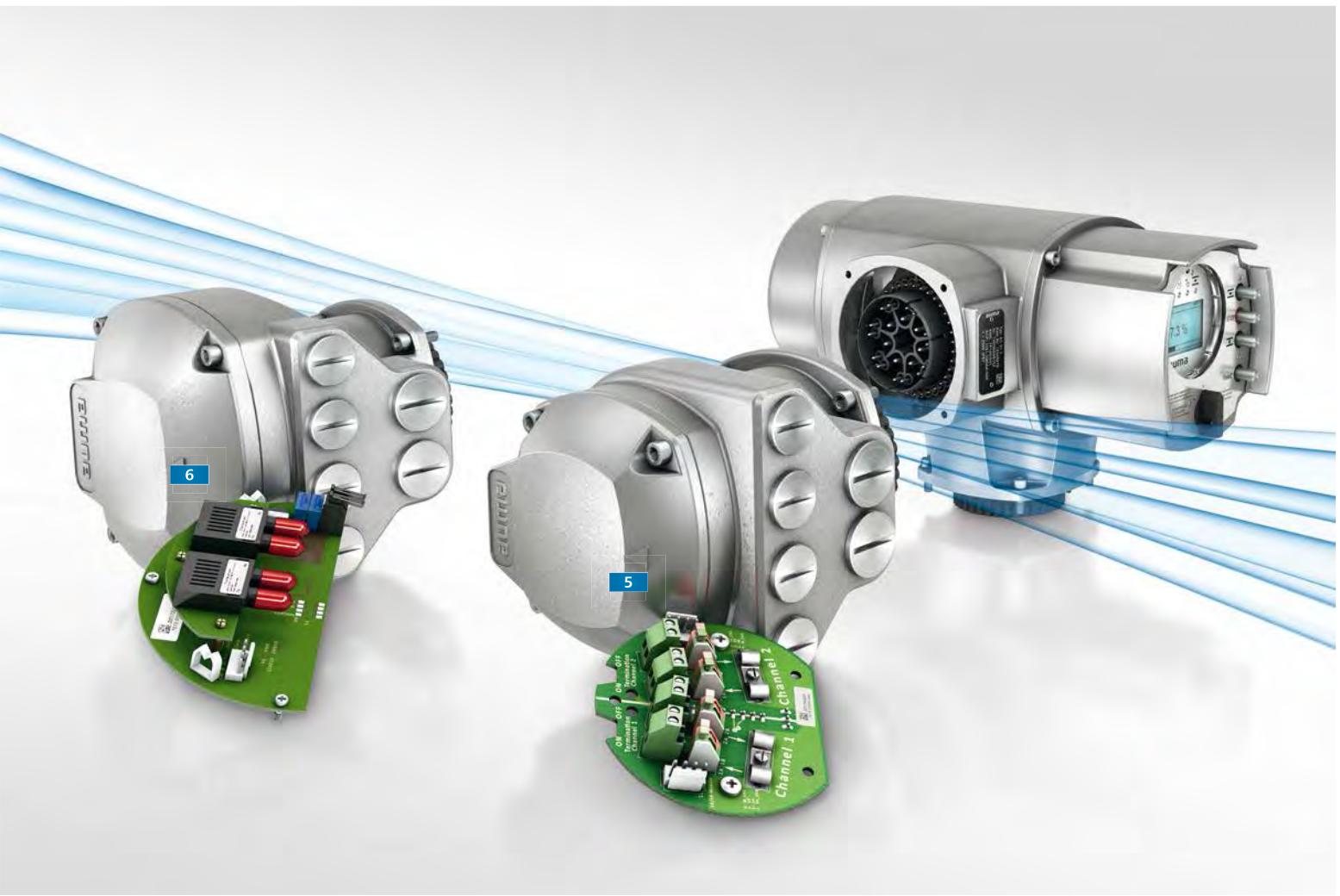

If communication via parallel signal transmission is required, AC is equipped with one of the electrical connections as described above. When using fieldbus technology, special connections are used. They are based on the plug-in design just like the other connectors.

5 Fieldbus connection SD

A connection board for easy connection of fieldbus cables is integrated. Fieldbus communication is not interrupted even when connector is removed. Connection is made via fieldbus specific characteristics. For example for Profibus as shown, termination resistors are integrated.

6 Fieldbus connection SDE with FO couplers

For direct connection of fibre optic cables to AC controls. Comparable in design to SD connection 5 but with larger diameter to comfortably accommodate the specified FO cable bending radii. The FO module contains diagnostic functions to monitor fibre optic cable quality.

MULTI-TURN ACTUATOR - PART-TURN GEARBOX COMBINATIONS - FOR LARGE TORQUE

Combining an SA multi-turn actuator with a GS part-turn gearbox results in a part-turn actuator. This combination generates large output torques as required for automating butterfly valves as well as ball and plug valves with large nominal diameters and/or high pressure values.

This device combination supplies torque values up to 675,000 Nm.

1 End stops

End stops serve the purpose of limiting the swing angle and to allow for precise valve positioning into the end positions during manual operation, especially if the valve is not equipped with own end stops. In motor operation, switching off is generated by the built-on SA multi-turn actuator, gearbox end stops are not reached in this mode.

For the AUMA design, the travelling nut **a** travels between both end stops **b** during operation. Advantages of this design:

- > Only relatively low input torques are applied to the end stops.
- > Excessive input torques have no impact on the housing. Even in the event of end stop break, the main gearbox remains undamaged and can still be operated.

A patented design consisting of two safety wedge discs **c** per end stop prevents travelling nut seizure at mechanical stop. The unseating torque required amounts to merely 60 % of the torque previously applied to approach the end stop.

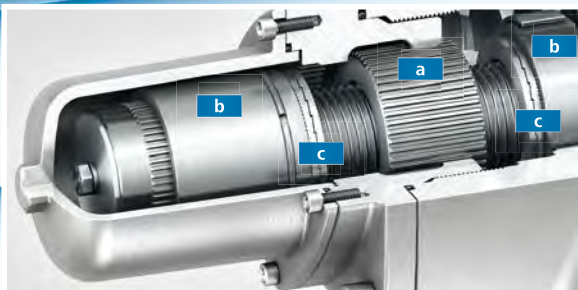

2 Worm wheel and worm shaft

They form the core components of the gearbox. The design allows high reduction ratios within one gear and has an important self-locking effect thus preventing valve position displacement in case external forces act upon the closing element.

3 Output mounting flange

In compliance with EN ISO 5211.

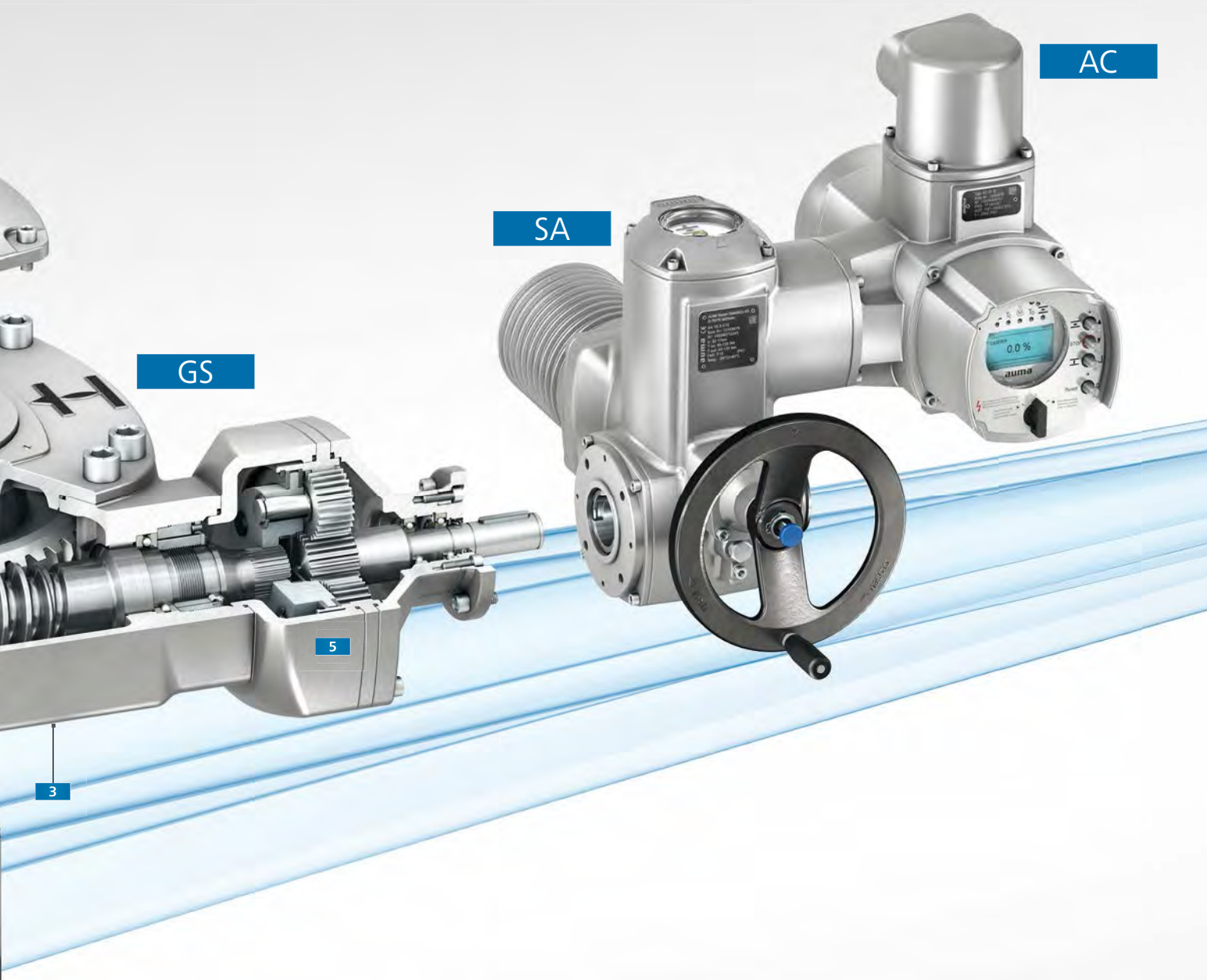

4 Coupling

The separate coupling enables easier mounting of the gearbox to the valve. On request, the coupling is supplied with a suitable bore for the valve shaft (please also refer to page 53). The coupling with bore is placed on the valve shaft and secured against axial movement. The gearbox can then be mounted onto the valve flange.

5 Primary reduction gearing

These planetary or spur gear stages ensure reduction of the required input torque.

6 Pointer cover

The large pointer cover allows perfect visibility of the valve position even at long distance. It continuously follows the valve movement and consequently serves the purpose of running indication. For high requirements with regard to enclosure protection, e.g. for buried service, a protective cover **6a** is used instead of the pointer cover.

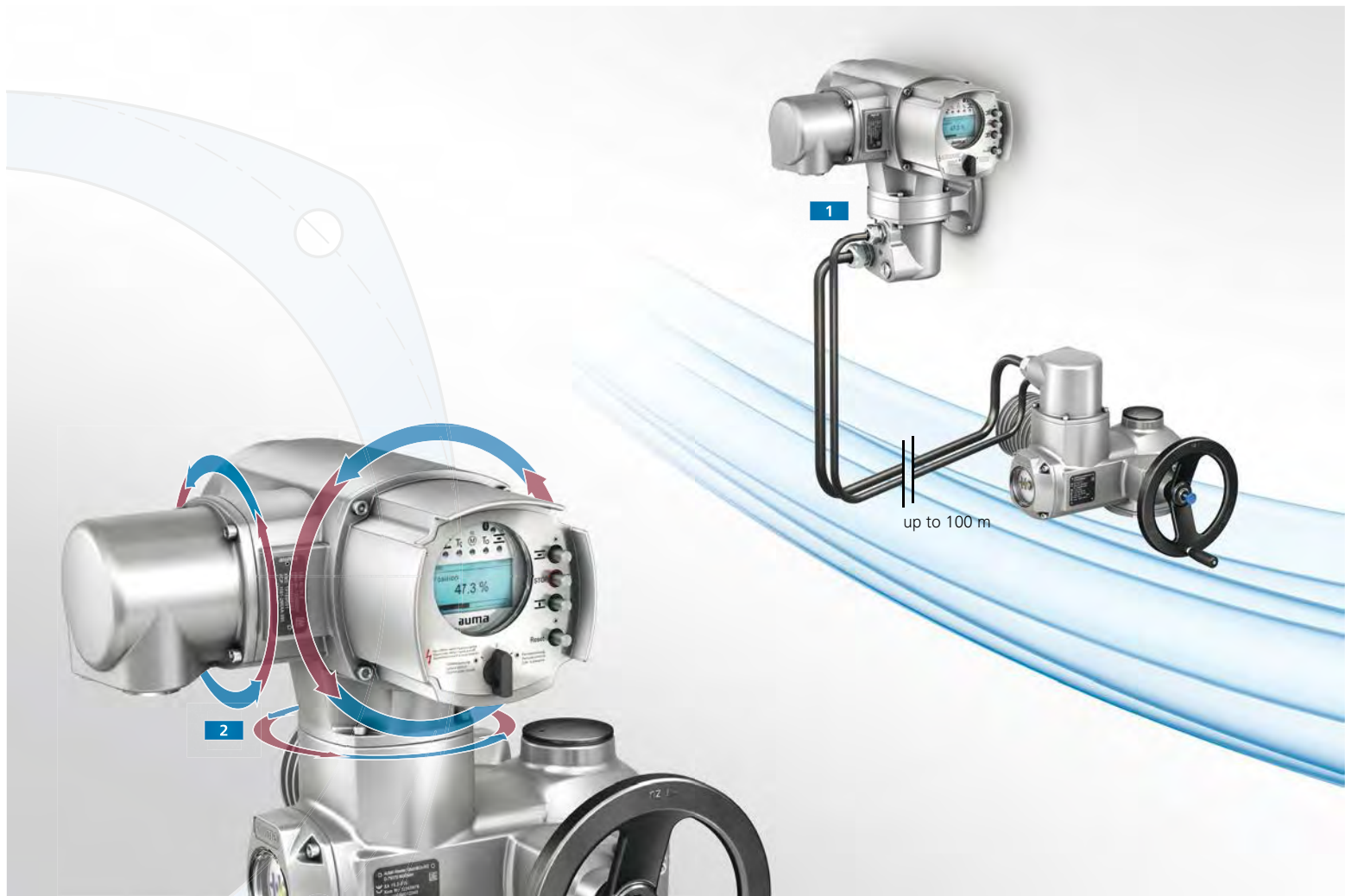

SPECIAL CIRCUMSTANCES - ADAPTING TO ANY MOUNTING POSITION

One of the many advantages of a modular design is the ease at which device configuration upgrade on site can be achieved.

1 Wall bracket

If the actuator is difficult to access or in case of extreme vibration or high ambient temperatures at the place of valve installation, controls with operating elements can be mounted separately from the actuator on a wall bracket. The cable length between actuator and controls may be up to 100 m. The wall bracket may easily be retrofitted at a later date.

2 Customisation of device positioning

The optimum positioning is easily adjustable thus avoiding the display being upside down, inaccessible operating elements, awkward cable gland alignments, etc. The correct position can easily be chosen.

The following positioning adjustments at 90° increments are possible: controls to actuator, local controls to controls as well as the electrical plug/socket connector. The plug/socket connections allow easy on-site adjustment of the mounting position.

3 GS part-turn gearbox variants

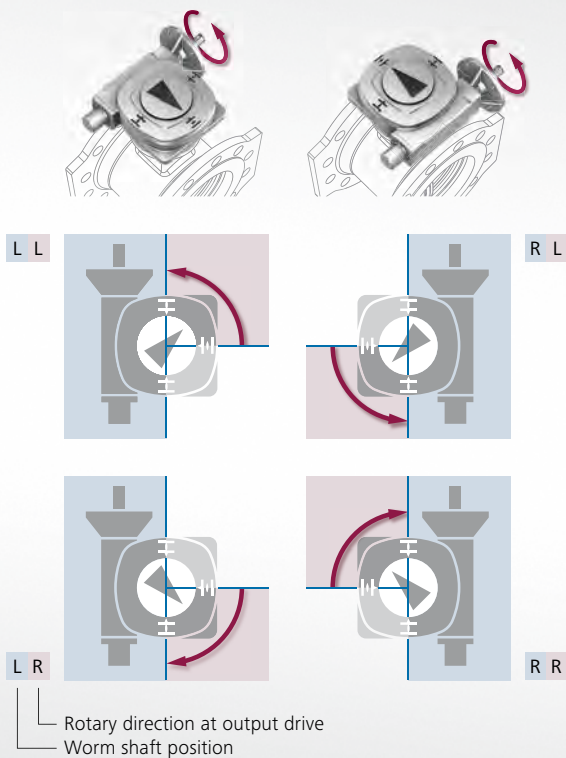

4 Mounting positions between actuator and gearbox

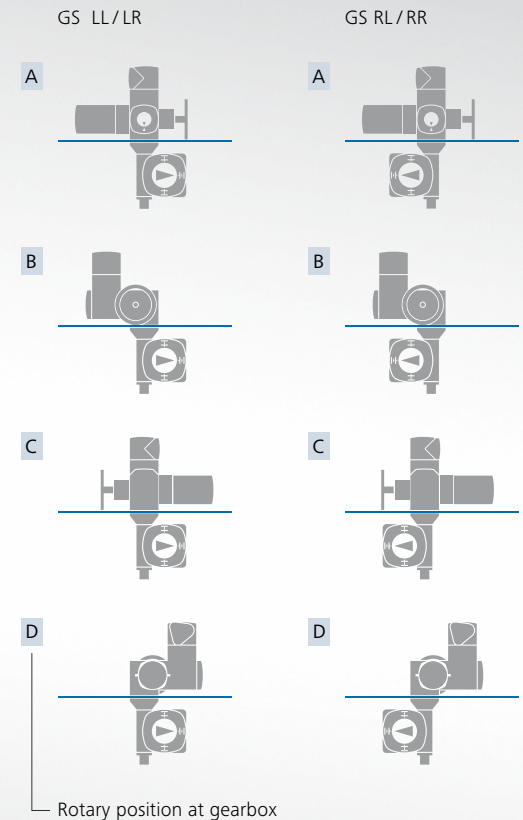

3 GS part-turn gearbox variants

The four variants expand the adaptation options with regard to the mounting position. This is due to the arrangement between worm shaft and worm wheel and the direction of rotation at output drive, with reference to a clockwise rotating input shaft.

- > **LL:** Worm shaft on left of worm wheel, counterclockwise rotation at output drive
- > **LR:** Worm shaft on left of worm wheel, clockwise rotation at output drive
- > **RL:** Worm shaft on right of worm wheel, counterclockwise rotation at output drive
- > **RR:** Worm shaft on right of worm wheel, clockwise rotation at output drive

4 Mounting positions of actuator and gearbox

Customising of device positioning as described in [2](#) is not limited to the actuator position. If AUMA actuators are ordered in combination with gearboxes, both devices can be mounted in four different positions, each rotated by 90°. Positions are marked with the letters A – D, the desired position can be indicated on the order.

Later adaptation on site is also possible. This applies to all AUMA multi-turn, part-turn, and lever gearboxes.

This document shows examples of the SA multi-turn actuator combined with GS part-turn gearbox variants. Separate documents describing the mounting positions are available for all gearbox types.

Actuators cannot always be accessed easily. Special applications demand special challenges.

Some application examples with the AUMA solutions are described below.

1 Operation elements for manual operation

1a Handwheel extension

For separate mounting of the handwheel



1b Adapter for power tool emergency operation

For manual emergency operation using a power tool.



1c Pit application with square head for power tool operation

Activation via square head for power tool



1d Chain wheel with remote switch-over

Activation via pull rope, scope of delivery without chain.



SPECIAL CIRCUMSTANCES - ADAPTING TO ANY MOUNTING POSITION



All examples illustrate how to use the items shown.

2 Installation in pits

Flooding and accessibility of the operation elements - depending on the importance of these factors - result in different installation requirements.

2a Floor pedestal

GS worm gearbox is mounted to valve, the multi-turn actuator is easily accessible due to the AUMA floor pedestal. Power transmission between actuator and gearbox is made via a cardan shaft.

2b Extension for pit installation with adapter for power tool operation

GS part-turn gearbox is mounted to valve, the multi-turn actuator is mounted separately from the gearbox. To make sure that actuator and gearbox flanges are aligned, a GK bevel gearbox is used. Emergency operation is performed from the pit cover. For this purpose, the actuator is equipped with an extension for pit installation. The end is made as square head to allow power tool operation. The manual emergency operation is activated by applying pressure on the power tool square head.

3 Synchronous operation - double-stem gate valves

In this application, it is of utmost importance to operate both stems simultaneously to avoid jamming the plate. The solution: Each stem is equipped with one GK bevel gearbox **3b**, both driven by an SA multi-turn actuator **3a**. In our example, the actuator is directly mounted to a gearbox, torque transmission to the second gearbox is performed via a shaft. Handwheel extensions **3c** make manual emergency operations much easier.

4 Emergency manual operation at a weir

Typically, weirs require adaptations to the special installation conditions. Actuators might be difficult to access. The chain wheel solutions including the switch-over function is a perfect solution for emergency manual operation, even in these difficult environments.



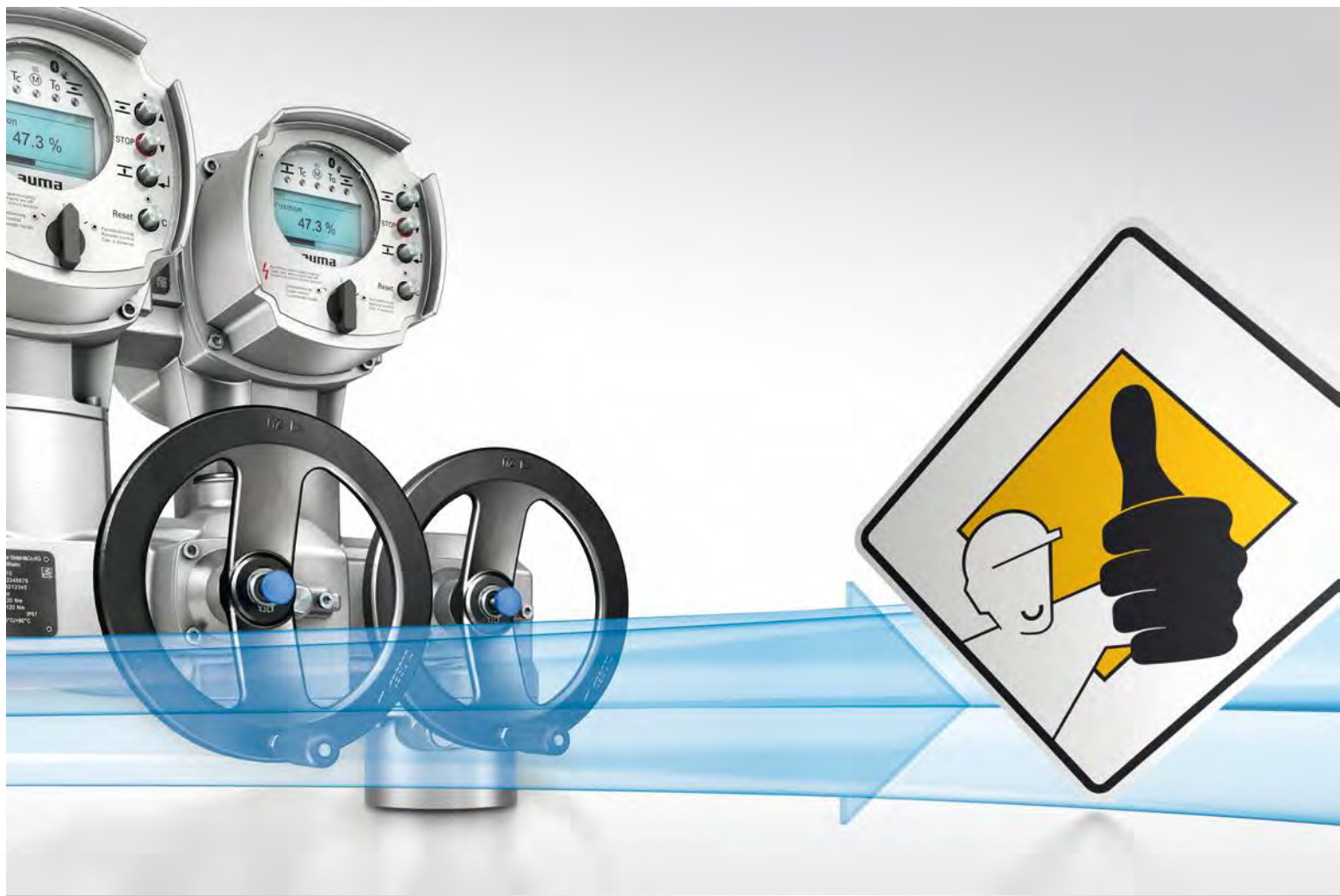

PROTECTION FOR VALVE, PROTECTION DURING OPERATION

AUMA actuators comply with global safety standards. They are equipped with a large variety of functions for safe and orderly operation while protecting the valve.

Correction of the direction of rotation

The automatic correction of the direction of rotation upon wrong phase sequence is an integral feature of the controls. If the phases are mixed up at the time of connecting the three-phase supply, the actuator still travels in the correct direction when receiving the respective operation command.

Valve overload protection

The controls switch off the actuator if inappropriate and excessive torque is applied during travel.

Protection tube for rising valve stem

The protection tube encloses a rising valve stem, thus protecting the stem against contamination and the plant operators against injury.



AUMA actuators are not exclusively installed in buildings or on company premises but are sometimes freely accessible to third parties. AUMA products can be equipped with a certain number of options preventing unauthorised operation of the actuators.

- 1 Locking device for handwheel**
 Activation of manual operation can be inhibited by means of a locking device **1a**. On the other hand, it is possible to inhibit automatic switching to motor operation once manual operation has been activated **1b**.
- 2 Remote lockout of AC local controls**
 Electrical actuator operation via the local controls is not possible without the enable signal from the control room.
- 3 Lockable selector switch**
 The selector switch for selecting the control mode can be protected against operation in all three positions: LOCAL, OFF, and REMOTE.
- 4 Lockable protection cover**
 Protects all operation elements from vandalism and unauthorised operation.
- 5 Protected AC Bluetooth connection**
 Password entry is required to establish a connection between a laptop or PDA and an actuator with integral controls.

Password protection for AC device parameters

Device parameters may only be changed after password entry.

Functional safety and SIL are terms frequently used in combination with safety of technical systems - promoted by the issue of new international standards.

AUMA actuators are frequently used in safety critical applications and therefore contribute to safe operation of technical systems. For this reason, functional safety is an important issue for us.

Certification

AUMA actuators in combination with AC actuator controls in SIL version are equipped with the safety functions "Emergency Shut Down (ESD)" and "Safe Stop" for safety-related applications, suitable up to SIL 3.



FUNCTIONAL SAFETY - SIL



Safety Integrity Level (SIL)

IEC 61508 defines 4 safety integrity levels. Depending on the risk, one of the four safety integrity levels is required for the safety-related system. A maximum permissible failure rate is assigned to each level. SIL 4 represents the highest level, SIL 1 the lowest level and thus the highest failure probability.

It has to be considered that the safety integrity level is a feature of a safety instrumented system (SIS) and not the characteristic of one single component. In general, a safety instrumented system includes the following components:

- > Sensor **1**
- > Controls (safety PLC) **2**
- > Actuator **3**
- > Valve **4**

AC .2 controls are ideal for sophisticated modulating tasks if communication via fieldbus is required or if the actuator must provide diagnostic information for operating parameter optimisation.

AUMA have developed a special SIL module for the AC .2 to utilise these functions in SIL 2 and SIL 3 applications.

The SIL module

The SIL module consists in an additional electronic unit, responsible for executing the safety functions. This SIL module is installed in integral AC .2 controls.

If a safety function is requested in the event of an emergency, the standard logic of AC .2 is by-passed and the safety function is performed via the SIL module.

The SIL modules integrate comparatively simple components such as transistors, resistors and capacitors for which the failure rates are completely known. Determined safety figures allow implementation in SIL 2 applications and, in redundant version (1oo2 - one out of two), in SIL 3 applications.

Priority of the safety function

Systems equipped with AC .2 in SIL version combine the functions of two controls. On the one hand, standard AC .2 functions can be used for "normal operation". On the other hand, the integral SIL module is used to perform the safety functions which always overrule normal operation. This is ensured due to the fact that the standard controls logic is by-passed when a safety function is requested.

Further information

For detailed information relating to the SIL topic, please refer to our separate brochure: "Functional Safety - SIL".

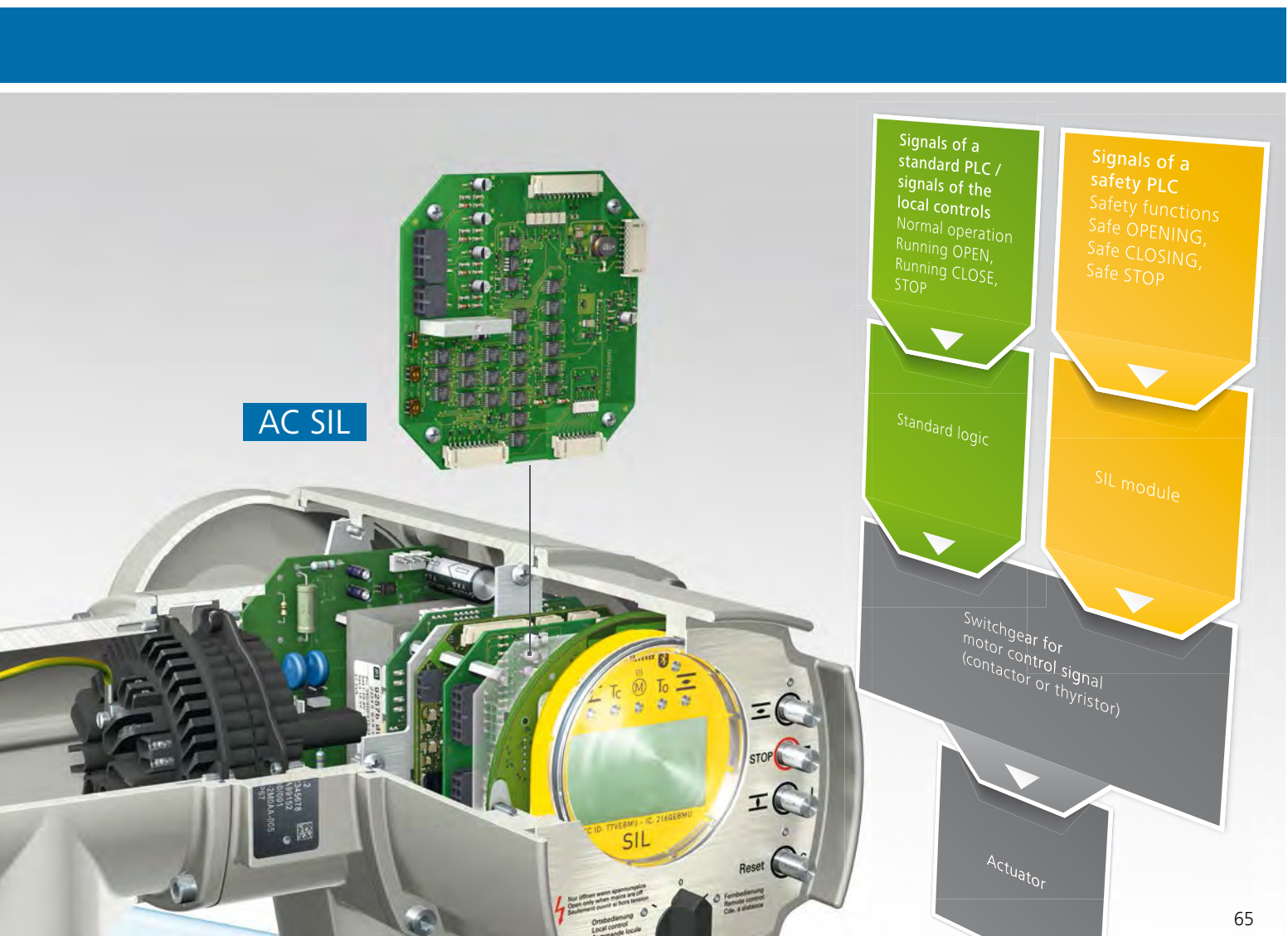

SA MULTI-TURN ACTUATORS AND SQ PART-TURN ACTUATORS

SA MULTI-TURN ACTUATORS FOR OPEN-CLOSE DUTY

The following data applies to actuators with 3-phase motors, operated in type of duty S2 - 15 min/classes A and B in compliance with EN 15714-2. For further information on other motor types and types of duty, refer to separate technical and electrical data sheets.

Type	Output speeds at 50 Hz ¹	Setting range for tripping torque	Number of starts Starts max.	Valve mounting flange	
	[rpm]	[Nm]	[1/h]	EN ISO 5210	DIN 3210
SA 07.2	4 – 180	10 – 30	60	F07 or F10	G0
SA 07.6	4 – 180	20 – 60	60	F07 or F10	G0
SA 10.2	4 – 180	40 – 120	60	F10	G0
SA 14.2	4 – 180	100 – 250	60	F14	G1/2
SA 14.6	4 – 180	200 – 500	60	F14	G1/2
SA 16.2	4 – 180	400 – 1,000	60	F16	G3
SA 25.1	4 – 90	630 – 2,000	40	F25	G4
SA 30.1	4 – 90	1,250 – 4,000	40	F30	G5
SA 35.1	4 – 45	2,500 – 8,000	30	F35	G6
SA 40.1	4 – 32	5,000 – 16,000	20	F40	G7
SA 48.1	4 – 16	10,000 – 32,000	20	F48	–

SAR MULTI-TURN ACTUATORS FOR MODULATING DUTY

The following data applies to actuators with 3-phase motors, operated in type of duty S4 - 25 %/class C in compliance with EN 15714-2. For further information on other motor types and types of duty, please refer to separate technical and electrical data sheets.

Type	Output speeds at 50 Hz ¹	Setting range for tripping torque	Maximum torque for modulating duty	Number of starts Starts max. ²	Valve mounting flange	
	[rpm]	[Nm]	[Nm]	[1/h]	EN ISO 5210	DIN 3210
SAR 07.2	4 – 90	15 – 30	15	1,500	F07 or F10	G0
SAR 07.6	4 – 90	30 – 60	30	1,500	F07 or F10	G0
SAR 10.2	4 – 90	60 – 120	60	1,500	F10	G0
SAR 14.2	4 – 90	120 – 250	120	1,200	F14	G1/2
SAR 14.6	4 – 90	250 – 500	200	1,200	F14	G1/2
SAR 16.2	4 – 90	500 – 1,000	400	900	F16	G3
SAR 25.1	4 – 11	1,000 – 2,000	800	300	F25	G4
SAR 30.1	4 – 11	2,000 – 4,000	1,600	300	F30	G5

SQ PART-TURN ACTUATORS FOR OPEN-CLOSE DUTY

The following data applies to actuators with 3-phase motors, operated in type of duty S2 - 15 min/classes A and B in compliance with EN 15714-2. For further information on other motor types and types of duty, please refer to separate technical and electrical data sheets.

Type	Operating times at 50 Hz ¹	Setting range for tripping torque	Number of starts Starts max.	Valve mounting flange	
	[s]	[Nm]	[1/h]	Standard (ISO 5211)	Option (EN ISO 5211)
SQ 05.2	4 – 32	50 – 150	60	F05/F07	F07, F10
SQ 07.2	4 – 32	100 – 300	60	F05/F07	F07, F10
SQ 10.2	8 – 63	200 – 600	60	F10	F12
SQ 12.2	16 – 63	400 – 1,200	60	F12	F10, F14, F16
SQ 14.2	24 – 100	800 – 2,400	60	F14	F16

SQR PART-TURN ACTUATORS FOR MODULATING DUTY

The following data applies to actuators with 3-phase motors, operated in type of duty S4 - 25 %/class C in compliance with EN 15714-2. For further information on other motor types and types of duty, please refer to separate technical and electrical data sheets.

Type	Operating times at 50 Hz ¹	Setting range for tripping torque	Maximum torque for modulating duty	Number of starts Starts max.	Valve mounting flange	
	[s]	[Nm]	[Nm]	[1/h]	Standard (ISO 5211)	Option (EN ISO 5211)
SQR 05.2	8 – 32	75 – 150	75	1,500	F05/F07	F07, F10
SQR 07.2	8 – 32	150 – 300	150	1,500	F05/F07	F07, F10
SQR 10.2	11 – 63	300 – 600	300	1,500	F10	F12
SQR 12.2	16 – 63	600 – 1 200	600	1,500	F12	F10, F14, F16
SQR 14.2	36 – 100	1,200 – 2,400	1,200	1,500	F14	F16

SWING ANGLE RANGES

Within the indicated swing angle ranges, the swing angle is freely adjustable.

	Swing angle range
Standard	75° – 105°
Option	15° – 45°; 45° – 75°; 105° – 135°; 135° – 165°; 165° – 195°; 195° – 225°

LIFETIME OF MULTI-TURN AND PART-TURN ACTUATORS

AUMA multi-turn and part-turn actuators of SA and SQ type ranges exceed the lifetime demands of EN 15714-2. Detailed information can be provided on request.

¹ fixed output speeds or operating times applying factor 1.4

² for the indicated higher output speeds, the maximum number of permissible starts is low, refer to technical data sheets.

SA MULTI-TURN ACTUATORS AND SQ PART-TURN ACTUATORS

CONTROL UNIT

Setting ranges of limit switching for SA and SAR

For multi-turn actuators, the control unit records the number of turns per stroke. There are two versions for various ranges.

	Turns per stroke	
	Electromechanical control unit	Electronic control unit
Standard	2 – 500	1 – 500
Option	2 – 5,000	10 – 5,000

ELECTRONIC CONTROL UNIT

When using the electronic control unit, reaching an end position, valve position, torque, temperature within the unit, and vibration are recorded in digital form and transmitted to AC integral controls. AC controls internally process all signals and provide appropriate indications via the respective communication interface.

Conversion of mechanical parameters into electronic signals is contactless and therefore reduces wear. The electronic control unit is prerequisite for non-intrusive setting of the actuator.

ELECTROMECHANICAL CONTROL UNIT

Binary and analogue signals of the electromechanical control unit are internally processed if AM or AC integral controls are supplied. For actuators without integral controls, signals are transmitted via electrical connection. In this case, the following technical data information for contacts and remote transmitters is required.

Limit/torque switches

Versions		
	Application/description	Type of contact
Single switch	Standard	One NC contact and one NO contact
Tandem switches (option)	For switching two distinct potentials. The switches have two compartments with galvanically isolated switches in a common sealed housing. The two switches are operated together; one switch is leading and should be used for signalisation.	Two NC contacts and two NO contacts
Triple switches (option)	For switching three distinct potentials. This version consists of one single and one tandem switch.	Three NC contacts and three NO contacts

Rated power	
Silver plated contacts	
U min.	24 V AC/DC
U max.	250 V AC/DC
I min.	20 mA
I max. AC current	5 A at 250 V (resistive load) 3 A at 250 V (inductive load, $\cos \varphi = 0,6$)
I max. DC current	0.4 A at 250 V (resistive load) 0.03 A at 250 V (inductive load, L/R = 3 μ s) 7 A at 30 V (resistive load) 5 A at 30 V (inductive load, L/R = 3 μ s)

Rated power	
Gold plated contacts (option)	
U min.	5 V
U max.	50 V
I min.	4 mA
I max.	400 mA

Switches - other features	
Operation	Lever
Contact element	Two snap action contacts

Blinker transmitter for running indication

Rated power	
Silver plated contacts	
U min.	10 V AC/DC
U max.	250 V AC/DC
I max. AC current	3 A at 250 V (resistive load) 2 A at 250 V (inductive load, $\cos \varphi \approx 0,8$)
I max. DC current	0.25 A at 250 V (resistive load)

Blinker transmitter - other features	
Operation	Segment washer
Contact element	Snap action contact
Type of contact	Change-over contact

ELECTROMECHANICAL CONTROL UNIT (CONT'D)

Remote position transmitter

Precision potentiometer for OPEN-CLOSE duty		
	Single	Tandem
Linearity	≤ 1 %	
Power	1.5 W	
Resistance (standard)	0.2 kΩ	0.2/0.2 kΩ
Resistance (option) further variants on request	0.1 kΩ, 0.5 kΩ, 1.0 kΩ, 2.0 kΩ, 5.0 kΩ	0.5/0.5 kΩ, 1.0/1.0 kΩ, 5.0/5.0 kΩ, 0.1/5.0 kΩ, 0.2/5.0 kΩ
Max. wiper current	30 mA	
Lifetime	100,000 cycles	

Precision film potentiometer for modulating duty		
	Single	Tandem
Linearity	≤ 1 %	
Power	0.5 W	
Resistance further variants on request	1.0 kΩ or 5 kΩ	1.0/5.0 kΩ or 5.0/5.0 kΩ
Max. wiper current	0.1 mA	
Lifetime	5m modulating steps	
Max. ambient temperature ¹	+90 °C	

Electronic position transmitter EWG		
	2-wire	3-wire/4-wire
Output signal	4 – 20 mA	0/4 – 20 mA
Power supply	24 V DC (18 – 32 V)	
Max. ambient temperature ¹	+80 °C (standard)/+90 °C (option)	

Electronic remote position transmitter RWG		
	2-wire	3/4-wire
Output signal	4 – 20 mA	0/4 – 20 mA
Power supply	14 V DC + (I x R _g), max. 30 V	24 V DC (18 – 32 V)

HANDWHEEL ACTIVATION

Rated power of microswitch to signal handwheel activation	
Silver plated contacts	
U min.	12 V DC
U max.	250 V AC
I max. AC current	3 A at 250 V (inductive load, cos φ = 0,8)
I max. DC current	3 A at 12 V (resistive load)

Microswitches for signalling handwheel activation – other features	
Operation	Lever
Contact element	Snap action contact
Type of contact	Change-over contact
Max. ambient temperature ¹	+80 °C

VIBRATION RESISTANCE

According to EN 60068-2-6.

Actuators withstand vibration during start-up or in case of plant failures up to 2 g, within the frequency range from 10 to 200 Hz. However, a fatigue strength may not be derived from this.

This data is valid for SA and SQ actuators without integral controls with AUMA plug/socket connector (S) but not in combination with gearboxes.

Complying to the conditions above, the applicable load limit for actuators with AM or AC integral controls amounts to 1 g.

MOUNTING POSITION

AUMA actuators, even when equipped with integral controls, can be operated without restriction in any mounting position.

NOISE LEVEL

The noise level originated by the actuator remains below the noise level of 72 dB (A).

¹ Ambient temperature range depends on temperature range of the actuator (refer to name plate).

SA MULTI-TURN ACTUATORS AND SQ PART-TURN ACTUATORS

SUPPLY VOLTAGES/MAINS FREQUENCIES

Hereafter, please find the standard supply voltages (other voltages upon request). Some actuator versions or sizes are not available with the stipulated motor types or voltages/frequencies. For detailed information, please refer to the separate electrical data sheets.

3-phase AC current

Voltages	Frequency
[V]	[Hz]
220; 230; 240; 380; 400; 415; 500; 525; 660; 690	50
440; 460; 480; 575; 600	60

1-phase AC current

Voltages	Frequency
[V]	[Hz]
230	50
115; 230	60

DC current

Voltages
[V]
24; 48; 60; 110; 220

Permissible fluctuations of mains voltage and frequency

- > Standard for SA, SQ, AM, and AC
 - Mains voltage: $\pm 10\%$
 - Frequency: $\pm 5\%$
- > Option for AC
 - Mains voltage: -30%
 - Requires special sizing when selecting the actuator.

MOTOR

Type of duty according to IEC 60034-1/EN 15714-2

Type	3-phase AC current	1-phase AC current	DC current
SA 07.2 – SA 16.2	S2 - 15 min, S2 - 30 min/ classes A,B	S2 - 15 min/ classes A,B ¹	S2 - 15 min/ classes A,B
SA 25.1 – SA 48.1	S2 - 15 min, S2 - 30 min/ classes A,B	–	–
SAR 07.2 – SAR 16.2	S4 - 25 %, S4 - 50 %/ class C	S4 - 25 %/ class C ¹	–
SAR 25.1 – SAR 30.1	S4 - 25 %, S4 - 50 %/ class C	–	–
SQ 05.2 – SQ 14.2	S2 - 15 min, S2 - 30 min/ classes A,B	S2 - 10 min/ classes A,B ¹	–
SQR 05.2 – SQR 14.2	S4 - 25 %, S4 - 50 %/ class C	S4 - 20 %/ class C ¹	–

Indications on type of duty refer to the following conditions: Nominal voltage, 40 °C ambient temperature, average load of approx. 35 % of maximum torque

Motor insulation classes

	Insulation classes
3-phase AC motors	F, H
1-phase AC motors	F
DC motors	F, H

Rated values for motor protection

Thermoswitches are used as motor protection as standard. When using integral controls, motor protection signals are internally processed. This also applies for the optional PTC thermistors. For actuators without integral controls, signals must be processed in external controls.

Rating of the thermoswitches	
1-phase AC voltage (250 V AC)	Switch rating I_{max}
$\cos \varphi = 1$	2.5 A
$\cos \varphi = 0.6$	1.6 A
DC voltage	Switch rating I_{max}
60 V	1 A
42 V	1.2 A
24 V	1.5 A

Special motors

For special requirements, the actuators can be equipped with special motors, e.g. brake motors or two-speed motors.

TERMINAL PLANS/ELECTRICAL CONNECTION

All diagrams show signal wirings to the 50 contact plug/socket connector and are the basis for connecting control cables and the power supply. They can be downloaded at www.auma.com.

- > TPA for SA/SAR multi-turn actuators and SQ/SQR part-turn actuators
- > MSP for AM controls
- > TPC for AC controls

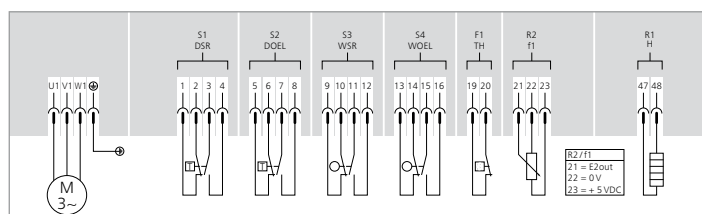

TPA terminal plan extract for an actuator

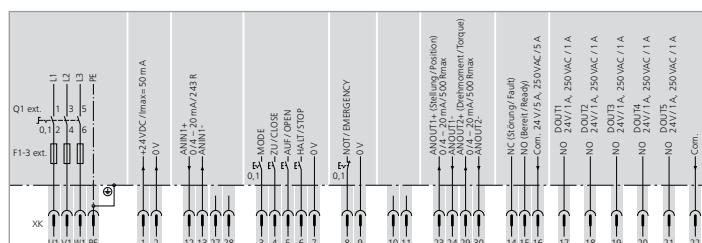

TPC terminal plan extract for AC controls

AUMA plug/socket connector

	Power contacts	Protective earth	Control contacts
No. of contacts max.	6 (3 equipped)	1 (leading contact)	50 pins/sockets
Designation	U1, V1, W1, U2, V2, W2	PE	1 to 50
Connection voltage max.	750 V	–	250 V
Rated current max.	25 A	–	16 A
Type of customer connection	Screw connection	Screw connection for ring lug	Screw connection, crimp-type (option)
Connection diameter max.	6 mm ²	6 mm ²	2.5 mm ²
Material - pin socket carrier	Polyamid	Polyamid	Polyamid
Material - contacts	Brass	Brass	Brass, tin plated or gold plated (option)

Thread dimensions of cable entries (selected choice)

	Electrical connection S	Electrical connection SH
M-threads (standard)	1 x M20 x 1.5; 1 x M25 x 1.5; 1 x M32 x 1.5	1 x M20 x 1.5; 2 x M25 x 1.5; 1 x M32 x 1.5
Pg-threads (option)	1 x Pg 13.5; 1 x Pg 21; 2 x Pg 29	1 x Pg 13.5; 2 x Pg 21; 2 x Pg 29
NPT-threads (option)	2 x 3/4" NPT; 1 x 1 1/4" NPT	1 x 3/4" NPT; 2 x 1" NPT; 1 x 1 1/4" NPT
G-threads (option)	2 x G 3/4"; 1 x G 1 1/4"	1 x G 3/4"; 2 x G 1"; 1 x G 1 1/4"

HEATER

Heater in control unit	Actuators without integral controls	Actuators with AM or AC
Heating element	Self-regulating PTC element	Resistance type heater
Voltage ranges	110 V – 250 V DC/AC 24 V – 48 V DC/AC 380 V – 400 V AC	24 V DC/AC (internal supply)
Power	5 W – 20 W	5 W

Motor heater	Actuators without integral controls	
Voltages	110 – 120 V AC, 220 – 240 V AC oder 380 – 400 V AC (external supply)	
Power	12.5 W – 25 W ²	
Heater for controls	AM	AC
Voltages	110 – 120 V AC, 220 – 240 V AC, 380 – 400 V AC	
Temperature-controlled power	40 W	60 W

² depending on motor size, please refer to separate technical data sheets.

AM AND AC ACTUATOR CONTROLS

LOCAL OPERATION - LOCAL CONTROLS

	AM	AC
Operation	Selector switch LOCAL - OFF - REMOTE, lockable in all three positions Push buttons OPEN, STOP, CLOSE	Selector switch LOCAL - OFF - REMOTE, lockable in all three positions Push buttons OPEN, STOP, CLOSE, Reset
Indication	3 indication lights: End position CLOSED, collective fault signal, end position OPEN –	5 indication lights: End position CLOSED, torque fault in direction CLOSE, motor protection tripped, torque fault in direction OPEN, end position OPEN Graphic display with changing white or red backlight Resolution 200 x 100 pixels

SWITCHGEAR

		AM and AC
		AUMA power classes
Reversing contactors, mechanically and electronically locked	Standard	A1
	Options	A2, A3, A4 ¹ , A5 ¹ , A6 ¹
Thyristors, electronically locked	Standard	B1
	Options	B2, B3

For more details on power classes and for thermal overload relay setting, please refer to the electrical data sheets.

AM AND AC – PARALLEL INTERFACE TO THE DCS

AM	AC
Input signals	
Standard Control inputs +24 V DC: OPEN, STOP, CLOSE via opto-isolator, one common	Standard Control inputs +24 V DC: OPEN, STOP, CLOSE, EMERGENCY, via optocoupler, OPEN, STOP, CLOSE with one common
Option As standard, with additional EMERGENCY input	Option As standard, with additional inputs for MODE and ENABLE
Option Control inputs at 115 V AC	Option Control inputs at 115 V AC, 48 V DC, 60 V DC, 110 V DC
Auxiliary available voltage for input signals	
24 V DC, max. 50 mA	24 V DC, max. 100 mA
115 V AC, max. 30 mA	115 V AC, max. 30 mA
Setpoint control	
	Analogue input 0/4 – 20 mA
Output signals	
Standard 5 output contacts, 4 NO contacts with one common, max. 250 V AC, 0.5 A (resistive load) Default configuration: End position CLOSED, end position OPEN, selector switch REMOTE, selector switch LOCAL 1 potential-free change-over contact, max. 250 V AC, 5 A (resistive load) for collective fault signal (torque fault, phase failure, motor protection tripped)	Standard 6 output contacts per parameter, to be assigned as desired, 5 NO contacts with one common, max. 250 V AC, 1 A (resistive load), 1 potential-free change-over contact, max. 250 V AC, 5 A (resistive load) Default configuration: End position CLOSED, end position OPEN, selector switch REMOTE, torque fault CLOSE, torque fault OPEN, collective fault signal (torque fault, phase failure, motor protection tripped)
	Option 12 output contacts can be assigned as desired using parameters, 10 NO contacts with one common, max. 250 V AC, 1 A (resistive load), 2 potential-free change-over contacts for collective fault signal max. 250 V AC, 5 A (resistive load)
	Option Change-over contacts without common, max. 250 V AC, 5 A (resistive load)
Permanent position feedback signal	
Position feedback signal, 0/4 – 20 mA	Position feedback signal, 0/4 – 20 mA

AC - FIELDBUS INTERFACE TO DCS

	Profibus	Modbus	Foundation Fieldbus	HART	Wireless
General information	Exchange of all discrete and continuous operation commands, feedback signals, status requests between actuators and DCS, as digital information				
Supported protocols	DP-V0, DP-V1, DP-V2	Modbus RTU	FF H1	HART	Wireless
Maximum number of participants	126 (125 field devices and one Profibus DP master) without repeater; i.e. max. 32 devices per Profibus DP segment	247 field devices and one Modbus RTU master Without repeater, i.e. max. 32 devices per Modbus segment	240 field devices including linking device. A maximum of 32 devices can be connected to a single Foundation Fieldbus segment.	64 field devices when implementing multidrop technology	250 per gateway
Max. cable lengths without repeater	Max. 1,200 m (for baud rates < 187.5 kbit/s), 1,000 m at 187.5 kbit/s, 500 m at 500 kbit/s, 200 m at 1.5 Mbit/s	Max. 1,200 m	Max. 1,900 m	approx 3,000 m	Distance covered Outside approx. 200 m, Inside buildings approx. 50 m
Max. cable lengths with repeater	Approx. 10 km (only applies to baud rates < 500 kbit/s), Approx. 4 km (at 500 kbit/s) Approx 2 km (at 1.5 Mbit/s) The maximum possible cable length depends on type and number of repeaters. Typically, maximum 9 repeaters can be used in one Profibus DP system.	Approx. 10 km The maximum possible cable length depends on type and number of repeaters. Typically, maximum 9 repeaters can be used in one Modbus system.	Approx. 9.5 km The maximum cable length which can be implemented depends on the number of repeaters. For FF, cascading of max. 4 repeaters possible.	Use of repeaters possible, max. cable length corresponds to conventional 4 – 20 mA wiring.	Each device acts as repeater. Subsequently arranged devices are used to cover large distances.
Overvoltage protection (option)	Up to 4 kV			–	not required
Data transmission via fibre optic cables					
Supported topologies	Line, star, ring	Line, star	–	–	–
Cable length between 2 actuators	Multi-mode: up to 2.6 km at 62.5 µm glass fibre	–	–	–	–
	Single-mode: up to 15 km	–	–	–	–

DCS INTEGRATION TESTS – SELECTION

Fieldbus	Manufacturer	DCS	Fieldbus	Manufacturer	DCS
Profibus DP	Siemens	S7-414H; Open PMC, SPPA T3000	Modbus	Allen Bradley	SLC 500; Series 5/40; ControlLogix Controller
	ABB	Melody AC870P; Freelance 800F; Industrial IT System 800 XA		Emerson	Delta-V
	OMRON	CS1G-H (CS1W-PRN21)		Endress & Hausser	Control Care
	Mitsubishi	Melsec Q (Q25H mit QJ71PB92V Master Interface)		General Electric	GE Fanuc 90-30
	PACTware Consortium e.V.	PACTware 4.1		Honeywell	TDC 3000; Experion PKS; ML 200 R
	Yokogawa	Centum VP (ALP 121 Profibus Interface)		Invensys/Foxboro	I/A Series
				Rockwell	Control Logix
Foundation Fieldbus	ABB	Industrial IT System 800 XA		Schneider Electric	Quantum Series
	Emerson	Delta-V; Ovation		Siemens	S7-341; MP 370; PLC 545-1106
	Foxboro/Invensys	I/A Series		Yokogawa	CS 3000
	Honeywell	Experion PKS R100/R300			
	Rockwell	RSFieldBus			
	Yokogawa	CS 3000			

AM AND AC CONTROLS

SUMMARY OF FUNCTIONS

	AM	AC
Operational functions		
Type of seating programmable	●	●
Automatic correction of the direction of rotation upon wrong phase sequence	●	●
Positioner	–	■
Feedback of intermediate positions	–	●
Approaching the intermediate positions directly from remote	–	■
Operation profiles with intermediate positions	–	■
Extended operating time due to timer	–	●
Programmable EMERGENCY behaviour	■	●
Failure behaviour on loss of signal	■	●
Torque by-pass	–	●
Integral PID controller	–	■
Multiport valve function	–	■
Monitoring functions		
Valve overload protection	●	●
Phase failure/phase sequence	●	●
Motor temperature (limit value)	●	●
Monitoring the admissible on-time (type of duty)	–	●
Manual operation activated	■	■
Operating time monitoring	–	●
Reaction upon receipt of operation command	–	●
Motion detector	–	●
Communication to DCS via fieldbus interface	–	■
Wire break monitoring, analogue inputs	–	●
Temperature of electronics	–	●
Diagnostics via continuous sensing of temperature, vibration	–	●
Heater monitoring	–	●
Monitoring of position transmitter in the actuator	–	●
Monitoring of torque sensing	–	●
Diagnostic functions		
Time-stamped event report	–	●
Electronic device ID	–	●
Operating data logging	–	●
Torque profiles	–	●
Status signals in compliance with NAMUR recommendation NE 107	–	●
Maintenance recommendations regarding O-rings, lubricant, reversing contactors, and mechanics.	–	●

● Standard

■ Option



GS part-turn gearboxes combined with SA multi-turn actuators act as part-turn actuators. Consequently, nominal torques up to 675,000 Nm can be achieved. These combinations complement the SQ type range for part-turn valves.



LIFETIME AS SIZING CRITERION - DUTY CLASSIFICATION FOR OPEN-CLOSE DUTY

EN 15714-2 defines lifetime requirements for actuators. Although not expressly demanded by this standard, AUMA meet the specified values for the AUMA gearbox range. This is the result of the concept that AUMA gearboxes are frequently supplied with AUMA actuators as one unit. This sizing complies with duty class 1 for the tables below. If lifetime requirements are lower, duty class 2 applies. Duty class 3 relates exclusively to manually operated valves for which the number of operations is considerably lower than for motor-driven gearboxes.

The duty classes exclusively apply to GS gearboxes. For actuators, EN 15714-2 applies, which does, however, not provide a comparable classification.

Definition of the duty classifications for AUMA part-turn gearboxes

- > Duty class 1 - motor operation
Lifetime for 90° swivel movement. Meets the lifetime requirements of EN 15714-2.
- > Duty class 2 - motor operation
Lifetime for 90° swivel movement for valves which are rarely operated.
- > Duty class 3 - manual operation
Meets the lifetime requirements of EN 1074-2.

	Duty class 1	Duty class 2	Duty class 3
Typ	Number of cycles for max. torque	Number of cycles for max. torque	Number of cycles for max. torque
GS 50.3	10,000	1,000	250
GS 63.3			
GS 80.3	5,000		
GS 100.3			
GS 125.3	2,500		
GS 160.3			
GS 200.3			
GS 250.3	1,000		
GS 315		-	-
GS 400			
GS 500			
GS 630.3			

SA/GS PART-TURN ACTUATORS

PART-TURN GEARBOXES AND PRIMARY REDUCTION GEARINGS - OPEN-CLOSE DUTY

The suggested, suitable multi-turn actuators have been selected as to achieve the maximum output torque. For less demanding torque requirements, smaller multi-turn actuators can be provided. Please refer to the separate technical data sheets for more detailed information.

Duty class 1 - motor operation with lifetime requirements according to EN 15714-2

Type	Max. output torque	Valve mounting flange	Total reduction ratio	Factor ¹	Input torque at max. output torque	Suitable multi-turn actuator for max. input torque	Operating time range for 50 Hz and 90° swing angle
	[Nm]	EN ISO 5211			[Nm]		[s]
GS 50.3	500	F07; F10	51:1	16.7	30	SA 07.2	9 – 191
GS 63.3	1,000	F10; F12	51:1	16.7	60	SA 07.6	9 – 191
GS 80.3	2,000	F12; F14	53:1	18.2	110	SA 10.2	9 – 199
GS 100.3	4,000	F14; F16	52:1	18.7	214	SA 14.2	9 – 195
			126:1	42.8	93	SA 10.2	11 – 473
			160:1	54	74	SA 10.2	13 – 600
			208:1	70.7	57	SA 07.6	17 – 780
GS 125.3	8,000	F16; F25; F30	52:1	19.2	417	SA 14.6	9 – 195
			126:1	44	182	SA 14.2	11 – 473
			160:1	56	143	SA 14.2	13 – 600
			208:1	72.7	110	SA 10.2	17 – 780
GS 160.3	14,000	F25; F30; F35	54:1	21	667	SA 16.2	9 – 203
			218:1	76	184	SA 14.2	18 – 818
			442:1	155	90	SA 10.2	37 – 1,658
GS 200.3	28,000	F30; F35; F40	53:1	20.7	1,353	SA 25.1	9 – 199
			214:1	75	373	SA 14.6	18 – 803
			434:1	152	184	SA 14.2	36 – 1,628
			864:1	268	104	SA 10.2	72 – 1,620 ²
GS 250.3	56,000	F35; F40	52:1	20.3	2,759	SA 30.1	9 – 195
			210:1	74	757	SA 16.2	35 – 788
			411:1	144	389	SA 14.6	34 – 1,541
			848:1	263	213	SA 14.2	71 – 1,590 ²
GS 315	90,000	F40; F48	53:1	23.9	3,766	SA 30.1	9 – 199
			424:1	162	556	SA 14.6	35 – 1,590
			848:1	325	277	SA 14.2	71 – 1,590 ²
			1,696:1	650	138	SA 10.2	141 – 1,590 ²
GS 400	180,000	F48; F60	54:1	24.3	7,404	SA 35.1	9 – 203
			432:1	165	1,091	SA 16.2	69 – 1,560 ²
			864:1	331	544	SA 14.6	72 – 1,620 ²
			1,728:1	661	272	SA 14.2	144 – 1,620 ²
GS 500	360,000	F60	52:1	23.4	15,385	SA 40.1	9 – 195
			832:1	318	1,132	SA 16.2	69 – 1,560 ²
			1,664:1	636	566	SA 14.6	139 – 1,560 ²
			3,328:1	1,147	314	SA 14.2	277 – 1,560 ²
GS 630.3	675,000	F90/AUMA	52:1	19.8	34,160	SA 48.1	49 – 195
			210:1	71.9	9,395	SA 40.1	98 – 788
			425:1	145.5	4,640	SA 35.1	142 – 1,594
			848:1	261.2	2,585	SA 30.1	141 – 1,590 ²
			1,718:1	528.8	1,275	SA 25.1	286 – 1,611 ²
			3,429:1	951.2	710	SA 16.2	286 – 1,607 ²
			6,939:1	1,924.8	350	SA 16.2	578 – 1,652 ²



Duty class 2 - motor operation if rarely operated

Type	Max. output torque	Valve mounting flange	Total reduction ratio	Factor ¹	Input torque at max. output torque	Suitable multi-turn actuator for max. input torque	Operating time range for 50 Hz and 90° swing angle
	[Nm]				[Nm]		[s]
GS 50.3	625	F07; F10	51:1	16.7	37	SA 07.6	9 – 191
GS 63.3	1,250	F10; F12	51:1	16.7	75	SA 10.2	9 – 191
GS 80.3	2,200	F12; F14	53:1	18.2	120	SA 10.2	9 – 199
GS 100.3	5,000	F14; F16	52:1	18.7	267	SA 14.6	9 – 195
			126:1	42.8	117	SA 10.2	11 – 473
			160:1	54	93	SA 10.2	13 – 600
			208:1	70.7	71	SA 10.2	17 – 780
GS 125.3	10,000	F16; F25; F30	52:1	19.2	521	SA 16.2	9 – 195
			126:1	44	227	SA 14.2	11 – 473
			160:1	56	179	SA 14.2	13 – 600
			208:1	72.7	138	SA 14.2	17 – 780
GS 160.3	17,500	F25; F30; F35	54:1	21	833	SA 16.2	9 – 203
			218:1	76	230	SA 14.2	18 – 818
			442:1	155	113	SA 10.2	37 – 1,658
			880:1	276	63	SA 10.2	73 – 1,650 ²
GS 200.3	35,000	F30; F35; F40	53:1	21.0	1,691	SA 25.1	9 – 199
			214:1	75.0	467	SA 14.6	18 – 803
			434:1	152	230	SA 14.2	36 – 1,628
			864:1	268	131	SA 14.2	72 – 1,620 ²
			1,752:1	552	63	SA 10.2	146 – 1,643 ²
GS 250.3	70,000	F35; F40; F48	52:1	20.3	3,448	SA 30.1	9 – 195
			210:1	74.0	946	SA 16.2	18 – 788
			411:1	144	486	SA 14.6	34 – 1,541
			848:1	263	266	SA 14.6	71 – 1,590 ²
			1,718:1	533	131	SA 14.2	143 – 1,611 ²

Duty class 3 - manual operation

Type	Max. output torque	Valve mounting flange	Total reduction ratio	Factor	Input torque at max. output torque
	[Nm]				[Nm]
GS 50.3	750	F07; F10	51:1	16.7	45
GS 63.3	1,500	F10; F12	51:1	16.7	90
GS 80.3	3,000	F12; F14	53:1	18.2	165
GS 100.3	6,000	F14; F16	52:1	18.7	321
			126:1	42.8	140
			160:1	54	111
			208:1	70.7	85
GS 125.3	12,000	F16; F25; F30	126:1	44	273
			160:1	56	214
			208:1	72.7	165
GS 160.3	17,500	F25; F30; F35	54:1	21	833
			218:1	76	230
			442:1	155	113
			880:1	276	63
GS 200.3	35,000	F30; F35; F40	434:1	152	230
			864:1	268	131
			1,752:1	552	63
GS 250.3	70,000	F35; F40; F48	848:1	263	266
			1,718:1	533	131

¹ Conversion factor from output torque to input torque to determine the multi-turn actuator size

² Limited by operation mode class B (S2 - 30 min)



PART-TURN GEARBOXES AND PRIMARY REDUCTION GEARINGS - MODULATING DUTY

The specified torques apply for modulating duty requiring a worm wheel made of bronze. Separate specification documents are available for other application requirements.

The suggested, suitable multi-turn actuators have been selected as to achieve the maximum output torque. For less demanding torque requirements, smaller multi-turn actuators can be provided. Please refer to the separate technical data sheets for more detailed information.

Type	Max. output torque [Nm]	Modulating torque [Nm]	Valve mounting flange EN ISO 5211	Total reduction ratio	Factor ¹	Input torque at max. output torque [Nm]	Suitable multi-turn actuator for max. input torque	Operating time range for 50 Hz and 90° swing angle [s]
GS 50.3	350	125	F05; F07; F10	51:1	17.9	20	SAR 07.2	9 – 191
GS 63.3	700	250	F10; F12	51:1	17.3	42	SAR 07.6	9 – 191
GS 80.3	1,400	500	F12; F14	53:1	19.3	73	SAR 10.2	9 – 199
GS 100.3	2,800	1,000	F14; F16	52:1	20.2	139	SAR 14.2	9 – 195
				126:1	44.4	63	SAR 10.2	21 – 473
				160:1	55.5	50	SAR 07.6	13 – 600
				208:1	77	37	SAR 07.6	35 – 780
GS 125.3	5,600	2,000	F16; F25	52:1	20.8	269	SAR 14.6	9 – 195
				126:1	45.4	123	SAR 14.2	21 – 473
				160:1	57.9	97	SAR 10.2	27 – 600
				208:1	77	73	SAR 10.2	35 – 780
GS 160.3	11,250	4,000	F25; F30	54:1	22.7	496	SAR 14.6	9 – 203
				218:1	83	136	SAR 14.2	36 – 818
				442:1	167	68	SAR 10.2	74 – 1,658
GS 200.3	22,500	8,000	F30; F35	53:1	22.3	1,009	SAR 25.1	72 – 199
				214:1	81.3	277	SAR 14.6	36 – 803
				434:1	165	137	SAR 14.2	72 – 1,628
				864:1	308	73	SAR 10.2	144 – 1,620 ²
GS 250.3	45,000	16,000	F35; F40	52:1	21.9	2,060	SAR 30.1	71 – 195
				210:1	80	563	SAR 16.2	35 – 788
				411:1	156	289	SAR 14.6	69 – 1,541
				848:1	305	148	SAR 14.2	141 – 1,590 ²
GS 315	63,000	30,000	F40; F48	53:1	26	2,432	SAR 30.1	72 – 199
				424:1	178	354	SAR 14.6	71 – 1,590
				848:1	356	177	SAR 14.2	141 – 1,590 ²
				1,696:1	716	88	SAR 10.2	283 – 1,590 ²
GS 400	125,000	35,000	F48; F60	54:1	26.5	4,717	SAR 30.1	74 – 203
		60,000		432:1	181	691	SAR 16.2	72 – 1,620
		864:1		363	344	SAR 14.6	144 – 1,620 ²	
		1,728:1		726	172	SAR 14.2	288 – 1,620 ²	
GS 500	250,000	35,000	F60	52:1	25.5	9,804	SAR 30.1	71 – 195
		120,000		832:1	350	714	SAR 16.2	139 – 1,560 ²
		1,664:1		416	358	SAR 14.6	277 – 1,560 ²	

SWING ANGLE RANGES

Like for SQ part-turn actuators, various swing angle ranges are available for SA/GS combinations. The ranges are independent of gearbox sizes. Please refer to the separate data sheets for more detailed information.

¹ Conversion factor from output torque to input torque to determine the multi-turn actuator size

² Limited by operation mode class C (S4 - 50 %)



SA MULTI-TURN ACTUATORS WITH GK MULTI-TURN GEARBOXES

GK bevel gearboxes in combination with SA multi-turn actuators act as multi-turn actuators with higher output torques. Drive shaft and output shaft are perpendicular. Thus, this combination is particularly appropriate for implementing special automation solutions. These include among others particular mounting positions or simultaneous operation of two valve stems using two GK gearboxes and a central actuator.



The following indications serve the purpose of a rough outline. Separate data sheets are available for GK gearboxes comprising detailed information. For further reduction ratios, please contact us.

Type	Max. output torque [Nm]	Modulating torque [Nm]	Valve mounting flange		Reduction ratios	Factor	Suitable multi-turn actuator	
			EN ISO 5211	DIN 3210			Open-close duty	Modulating duty
GK 10.2	120	60	F10	G0	1:1	0.9	SA 07.6; SA 10.2; SA 14.2	SAR 07.6; SAR 10.2; SAR 14.2
					2:1	1.8		
GK 14.2	250	120	F14	G1/2	2:1	1.8	SA 10.2; SA 14.2	SAR 10.2; SAR 14.2
					2.8:1	2.5		
GK 14.6	500	200	F14	G1/2	2.8:1	2.5	SA 10.2; SA 14.2	SAR 10.2; SAR 14.2
					4:1	3.6		
GK 16.2	1,000	400	F16	G3	4:1	3.6	SA 14.2; SA 14.6	SAR 14.2
					5.6:1	5.0		
GK 25.2	2,000	800	F25	G4	5.6:1	5.0	SA 14.2; SA 14.6	SAR 14.2; SAR 14.6
					8:1	7.2		
GK 30.2	4,000	1,600	F30	G5	8:1	7.2	SA 14.6; SA 16.2	SAR 14.6; SAR 16.2
					11:1	9.9		
GK 35.2	8,000	–	F35	G6	11:1	9.9	SA 14.6; SA 16.2	–
					16:1	14.4		
GK 40.2	16,000	–	F40	G7	16:1	14.4	SA 16.2; SA 25.1	–
					22:1	19.8		



SA MULTI-TURN ACTUATORS WITH GST MULTI-TURN GEARBOXES

GST spur gearboxes in combination with SA multi-turn actuators act as multi-turn actuators with higher output torques. Drive shaft and output shaft are arranged in axial offset position. Thus, this combination is particularly appropriate for implementing special automation solutions. This includes among others particular installation conditions.



The following indications serve the purpose of a rough outline. Separate data sheets are available for GST gearboxes comprising detailed information. For further reduction ratios, please contact us.

Type	Max. output torque	Modulating torque	Valve mounting flange		Reduction ratios	Factor	Suitable multi-turn actuator	
			EN ISO 5211	DIN 3210			Open-close duty	Modulating duty
GST 10.1	120	60	F10	G0	1:1	0.9	SA 07.6; SA 10.2; SA 14.2	SAR 07.6; SAR 10.2; SAR 14.2
					1.4:1	1.3		
					2:1	1.8		
GST 14.1	250	120	F14	G1/2	1.4:1	1.3	SA 10.2; SA 14.2	SAR 10.2; SAR 14.2
					2:1	1.8		
					2.8:1	2.5		
GST 14.5	500	200	F14	G1/2	2:1	1.8	SA 10.2; SA 14.2	SAR 10.2; SAR 14.2
					2.8:1	2.5		
					4:1	3.6		
GST 16.1	1,000	400	F16	G3	2.8:1	2.5	SA 14.2; SA 14.6	SAR 14.2
					4:1	3.6		
					5.6:1	5.0		
GST 25.1	2,000	800	F25	G4	4:1	3.6	SA 14.2; SA 14.6	SAR 14.2; SAR 14.6
					5.6:1	5.0		
					8:1	7.2		
GST 30.1	4,000	1,600	F30	G5	5.6:1	5.0	SA 14.6; SA 16.2	SAR 14.6; SAR 16.2
					8:1	7.2		
					11:1	9.9		
GST 35.1	8,000	–	F35	G6	8:1	7.2	SA 14.6; SA 16.2	–
					11:1	9.9		
					16:1	14.4		
GST 40.1	16,000	–	F40	G7	11:1	9.9	SA 16.2; SA 25.1	–
					16:1	14.4		
					22:1	19.8		



SA MULTI-TURN ACTUATORS WITH GHT MULTI-TURN GEARBOXES

GHT worm gearboxes in combination with SA multi-turn actuators act as multi-turn actuators with high output torques. The torque range increases nearly fourfold when combining GHT gearboxes with SA actuators. This type of torque requirements occurs e.g. for large gate valves, weir penstocks or dampers.



The following indications serve the purpose of a rough outline. Separate data sheets are available for GHT gearboxes comprising detailed information. For further reduction ratios, please contact us

Type	Output torque	Valve mounting flange	Reduction ratios	Factor	Suitable multi-turn actuator
	[Nm]	EN ISO 5211			
GHT 320.3	32,000	F48	10:1	8	SA 30.1
			15.5:1	12.4	SA 25.1
			20:1	16	SA 25.1
GHT 500.3	50,000	F60	10.25:1	8.2	SA 35.1
			15:1	12	SA 30.1
			20.5:1	16.4	SA 30.1
GHT 800.3	80,000	F60	12:1	9.6	SA 35.1
			15:1	12	SA 35.1
GHT 1200.3	120,000	F60	10.25:1	8.2	SA 40.1
			20.5:1	16.4	SA 35.1



SQ PART-TURN ACTUATORS WITH BASE AND LEVER

By mounting a lever and a base, the SQ actuator turns into a lever actuator. The technical data of these lever actuators is identical to that of the part-turn actuators, including, for example, the maximum permissible number of starts. On the right, please find the data for lever actuators equipped with 3-phase AC motors. Operating times apply for 90° swing angle.



SQ - open-close duty

Type	Operating times at 50 Hz	Setting range for tripping torque
	[s]	[Nm]
SQ 05.2	4 – 32	50 – 150
SQ 07.2	4 – 32	100 – 300
SQ 10.2	8 – 63	200 – 600
SQ 12.2	16 – 63	400 – 1,200
SQ 14.2	24 – 100	800 – 2,400

SQR - modulating duty

Type	Operating times at 50 Hz	Setting range for tripping torque	Permissible average torque for modulating duty
	[s]	[Nm]	[Nm]
SQR 05.2	8 – 32	75 – 150	75
SQR 07.2	8 – 32	150 – 300	150
SQR 10.2	11 – 63	300 – 600	300
SQR 12.2	16 – 63	600 – 1,200	600
SQR 14.2	36 – 100	1,200 – 2,400	1,200

SA MULTI-TURN ACTUATORS WITH GF LEVER GEARBOXES

SA multi-turn actuators combined with GF gearboxes act as lever actuators.

Lever gearboxes are derived from GS part-turn gearboxes with regard to design. Various reduction ratios are achieved by integrating primary reduction gearings.

The following indications serve the purpose of a rough outline. Please refer to the separate data sheets for more detailed information. Gearboxes provided for modulating applications are equipped with a worm wheel made of bronze. The nominal torque is reduced for this version.



Type	Max. output torque	Modulating torque	Total reduction ratio	Suitable multi-turn actuator	
	[Nm]	[Nm]		Open-close duty	Modulating duty
GF 50.3	500	125	51:1	SA 07.2	SAR 07.2
GF 63.3	1,000	250	51:1	SA 07.6	SAR 07.6
GF 80.3	2,000	500	53:1	SA 10.2	SAR 10.2
GF 100.3	4,000	1,000	52:1	SA 14.2	SAR 14.2
			126:1	SA 10.2	SAR 10.2
			160:1	SA 10.2	SAR 07.6
			208:1	SA 07.6	SAR 07.6
GF 125.3	8,000	2,000	52:1	SA 14.6	SAR 14.6
			126:1	SA 14.2	SAR 14.2
			160:1	SA 14.2	SAR 10.2
			208:1	SA 10.2	SAR 10.2
GF 160.3	11,250	4,000	54:1	SA 16.2	SAR 14.6
			218:1	SA 14.2	SAR 14.2
			442:1	SA 10.2	SAR 10.2
			53:1	SA 25.1	SAR 25.1
GF 200.3	22,500	8,000	214:1	SA 14.6	SAR 14.6
			434:1	SA 14.2	SAR 14.2
			864:1	SA 10.2	SAR 10.2
			52:1	SA 30.1	SAR 30.1
GF 250.3	45,000	16,000	210:1	SA 16.2	SAR 16.2
			411:1	SA 14.6	SAR 14.6
			848:1	SA 14.2	SAR 14.2



SA MULTI-TURN ACTUATORS WITH LE LINEAR THRUST UNITS

When mounting LE linear thrust units to SA multi-turn actuators, they act as linear actuators, also referred to as linear thrust units.

The following indications serve the purpose of a rough outline. Please refer to the separate data sheets for more detailed information.



Type	Stroke ranges	Thrust		Suitable multi-turn actuator	
	max. [mm]	max. [kN]	for modulating torque [kN]	Open-close duty	Modulating duty
LE 12.1	50	11.5	6	SA 07.2	SAR 07.2
	100				
	200				
	400				
	500				
LE 25.1	50	23	12	SA 07.6	SAR 07.6
	100				
	200				
	400				
	500				
LE 50.1	63	37.5	20	SA 10.2	SAR 10.2
	125				
	250				
	400				
LE 70.1	63	64	30	SA 14.2	SAR 14.2
	125				
	250				
	400				
LE 100.1	63	128	52	SA 14.6	SAR 14.6
	125				
	250				
	400				
LE 200.1	63	217	87	SA 16.2	SAR 16.2
	125				
	250				
	400				

EU DIRECTIVES

Declaration of Incorporation in compliance with the Machinery Directive and Declaration of Conformity according to the Low Voltage and EMC Directives.

According to the Machinery Directive, AUMA actuators and actuator controls are considered as partly completed machinery. By means of the Declaration of Incorporation, AUMA certify that during the design stage of the devices, the fundamental safety requirements stipulated in the Machinery Directive were applied.

AUMA actuators fulfil the requirements of the Low Voltage and EMC Directives. This has been proved in various exams and extensive tests. Consequently, AUMA issue a Declaration of Conformity in compliance with the Low Voltage and EMC Directives.

Declarations of Incorporation and of Conformity are combined in a single certificate.

According to the Low Voltage and EMC directives, the devices are labelled with the CE mark.



INSPECTION CERTIFICATE

After assembly, all actuators are thoroughly tested and torque switches are calibrated. This process is recorded in the inspection certificate.

CERTIFICATES

Notified bodies perform type tests on the actuators to prove whether the devices are suitable for specifically defined applications. One example are the tests to prove electrical safety for the North American market. For all devices mentioned in this brochure, relevant certificates are available.

Where can I get the certificates?

All confirmations, records and certificates are filed at AUMA and provided as printed or digital version on request.

The documents can be downloaded from the AUMA website at any time; some of them are password protected.

> www.auma.com

Service conditions	
Type of protection.....	14
Low temperature version.....	15
High temperature version.....	15
Corrosion protection.....	16
Basics	
Open-close duty.....	18
Modulating duty.....	18
Motor duty types.....	18
Number of starts.....	18
Type of seating, limit/torque seating.....	19
OPEN-CLOSE control.....	18
Setpoint control.....	19
Integral controls.....	21
External controls.....	20
Electromechanical control unit	
Limit switches.....	50, 68
Torque switches.....	50, 68
Intermediate position switches.....	50, 68
Switches in tandem version.....	50, 68
Mechanical position indicator for visual valve position indication.....	51
Electronic position transmitter for remote position indication.....	50, 68
Electronic control unit	
Continuous position recording.....	51
Continuous torque sensing.....	51
Continuous temperature and vibration sensing.....	51
EMERGENCY operation	
Handwheel with ball handle.....	48
Handwheel extension.....	60
Adapter for power tool emergency operation.....	60
Version for pit installation.....	60
Chain wheel.....	60
Electrical connections	
Electrical connections/AUMA plug/socket connector:.....	54
Electrical connection S.....	54, 71
Electrical connection SH.....	54, 71
Fieldbus connection SD.....	55
Intermediate frame DS for double sealing.....	54
Valve attachments for multi-turn actuators according to EN ISO 5210	
Output drive types B1, B2, B3 or B4.....	52
Output drive type A.....	52
Special output drive types (AF, AK, AG, isolated output drive types, hexagon in coupling).....	52
Valve attachments for part-turn actuators according to EN ISO 5211	
Coupling unbored.....	53, 57
Coupling with bore (two-flat, square or bore with keyway).....	53
Coupling, extended version.....	53
Communication interfaces	
Parallel interfaces.....	33
Profibus DP.....	35
Modbus RTU.....	36
Foundation Fieldbus.....	37
Remote parameterisation/diagnostics via fieldbus.....	39
Wireless.....	42
Fibre optic cable.....	43
SIMA Master Station.....	40

Local controls - operation - setting

Selector switch LOCAL - OFF - REMOTE	24
Push buttons for operation on site.....	25
Graphic display	24
Setting via programming switches.....	22
Setting via software parameters (request via display)	24
Non-Intrusive setting of end positions and tripping torques	25
Bluetooth interface for connection to laptop/PDA.....	28

Switchgears

Reversing contactors	49, 72
Thyristors (recommended for actuators with high number of starts)	49, 72

Application functions

Limit seating in the end positions	19
Torque seating in the end positions	19
OPEN - CLOSE / OPEN - STOP - CLOSE control	18
Setpoint control for integral positioner	19

Failure and protective functions

Functional safety - SIL	64
Automatic correction of the direction of rotation upon wrong phase sequence.....	62
Locking device for handwheel	63
Lockable selector switch at local controls	63
Lockable protection cover for local controls.....	63
Remote lockout of local controls.....	63
Password protected parameters.....	24,63
Valve overload protection.....	19, 62
Protection for motor against overheating	19, 70
Protection tube for rising valve stem.....	62

Diagnostics, maintenance indications, corrective actions

Torque measurement.....	46
Vibration measurement	51
Temperature measurement	49, 51
Recording of characteristics.....	30
Event report with time stamp/operating data logging	27
Maintenance recommendations regarding O-rings, lubricant, reversing contactors, and mechanics	26
Maintenance schedule according to NAMUR (NE 107).....	27

Setting and operation software AUMA CDT

(download free of charge at www.auma.com)

Operation of actuator	28
Setting the AC/the actuator	28
Safeguarding the device parameters in a database.....	28
Reading out and safeguarding the operating data/the event report.....	28
Characteristics recording via Live View	30

AUMA Riester GmbH & Co. KG

Aumastr. 1

D-79379 Muellheim

Tel +49 7631-809-0

Fax +49 7631-809-1250

info@auma.com

AUMA subsidiaries or representatives
are implanted in more than 70 countries. For
detailed contact information, please refer to
www.auma.com