

Descripción

Válvula de mariposa de eje céntrico con elastómero-asiento para fluidos y gases en la industria como edificación, sector de aguas.....

Características

- Tipos de cuerpo D1 Tipo Wafer DN 25-1000
D3 Tipo Lug DN 25-600
D4 Sección en U DN 150-1600
- Ancho del cuerpo Según ISO 5752/20, EN 558-1/20
- Construcciones Según EN 593 / API 609 categoría A (bajo demanda)
- Brida superior Según EN ISO 5211
- Presión máxima 16 bar (20 bar bajo demanda)
- Tipos de bridas PN6, PN10, PN16, ANSI cl. 150
- Rango de temperatura -20°C ÷ 140°C según mat. (200°C bajo demanda)
- Prueba de estanqueidad Según EN 12266-1/P12, grado A test fluid water
Según API 598 (bajo demanda)

CE

Las válvulas de mariposa cumplen los requisitos de seguridad del anexo en la directiva europea para equipos de presión 2014/68/UE (PED) para fluidos grupo 1 y 2.

SIL

Válvulas DESPONIA® se pueden utilizar en sistemas relacionados con la seguridad según IEC 61508 / 61511, Nivel de Integridad de Seguridad SIL 2



Versiones especiales de válvulas DESPONIA® se pueden utilizar en atmósferas explosivas

FDA y CE 1935/2004

Diferentes discos y asientos cumplen con FDA y CE 1935/2004

Emisión fugitiva

EN ISO 15848-1 para ciertos materiales

Fat Free y Lab Free

Ejecuciones especiales libres de grasa, siliconas y otras sustancias que interfieren con la pintura



D1
Wafer

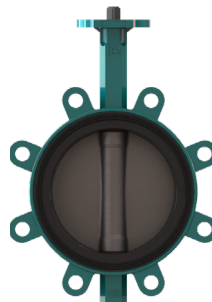

D3
Lug



D4
Sección en U

Construcción

1	Cuerpo (el cuello mas largo permite calorifugación)
2	El eje con indicador de posición
3	Disco
4	Asiento intercambiable con estrías de estanqueidad en zona de contacto
5	Cojinete, DN25-400 Resicoat®, DN450-1600 Bronce
6	Junta torica
7	Collar de retención

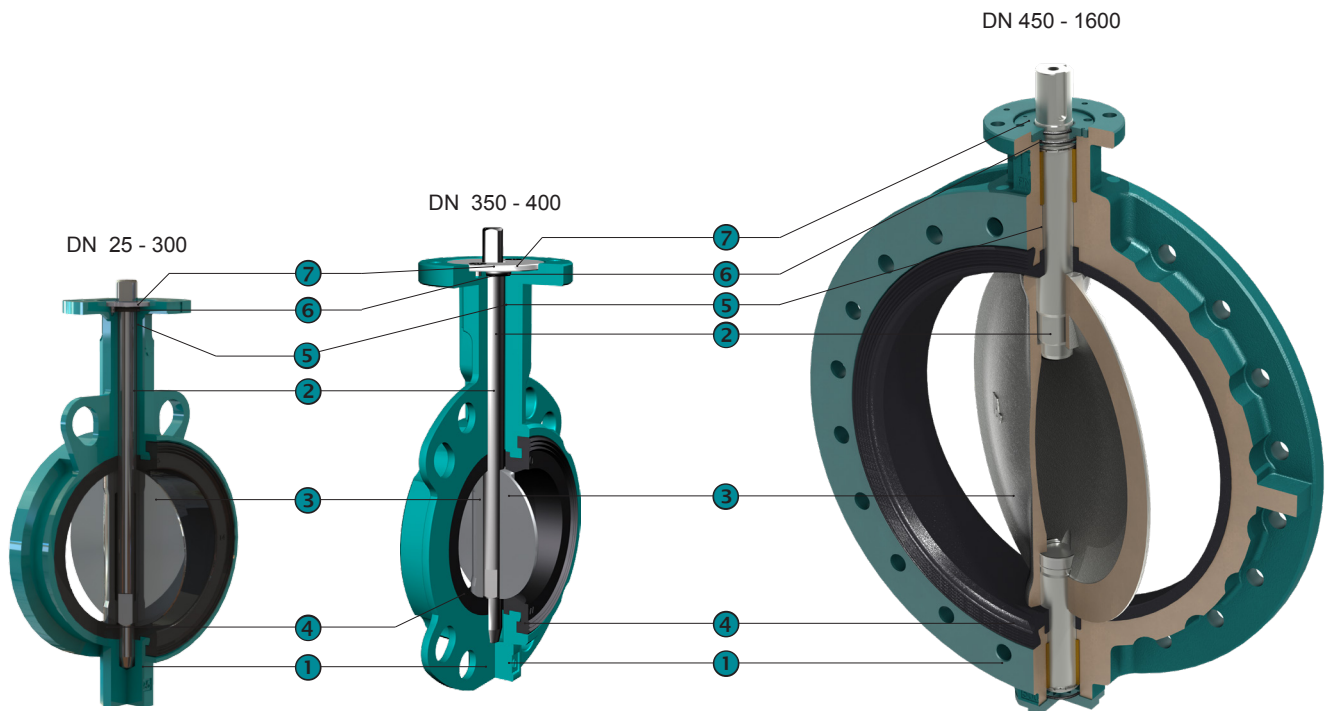

Valores Kv m³/h

Angulos de apertura de la válvula

DN	20°	30°	40°	50°	60°	70°	80°	90°
25/32		1,5	5	10	15	26	34	40
40		2,7	8,5	16	25	37	46	50
50	2	7	15	28	45	68	88	100
65	3	11	24	48	85	138	180	210
80	8	22	50	83	134	230	312	360
100	15	35	70	130	225	410	585	650
125	28	70	135	230	360	600	920	1050
150	33	95	205	320	580	980	1410	1620
200	60	175	355	580	910	1600	2450	2800
250	132	340	590	940	1480	2550	3950	4480
300	200	505	890	1450	2100	3800	5960	6800
350	280	680	1200	2050	3150	5050	8100	9200
400	365	860	1500	2490	3980	6600	10200	11700
450	465	1080	1900	3150	5050	8700	13300	15200
500	580	1200	2300	3740	6150	11000	16800	18900
600	820	1600	2780	5200	8940	14500	23500	26800
700	890	2050	3450	6050	11050	18800	31500	37100
800	1300	2550	4950	8750	14200	23500	39500	48500
900	1650	3300	6400	11800	19400	31500	52500	61300
1000	2150	4250	8200	15100	23500	39400	65500	80500
1100	3445	6525	11210	18390	30850	50600	88460	107590
1200	4000	7500	12500	19800	34000	55400	98300	119200
1300	4600	8810	15350	26150	42750	72450	120150	140600
1400	5200	10120	18200	32500	51500	89500	142000	162000
1500	6055	11958	21820	38180	60280	102850	166590	192250
1600	7100	14210	26050	45000	71200	118500	196200	228500

Caudal

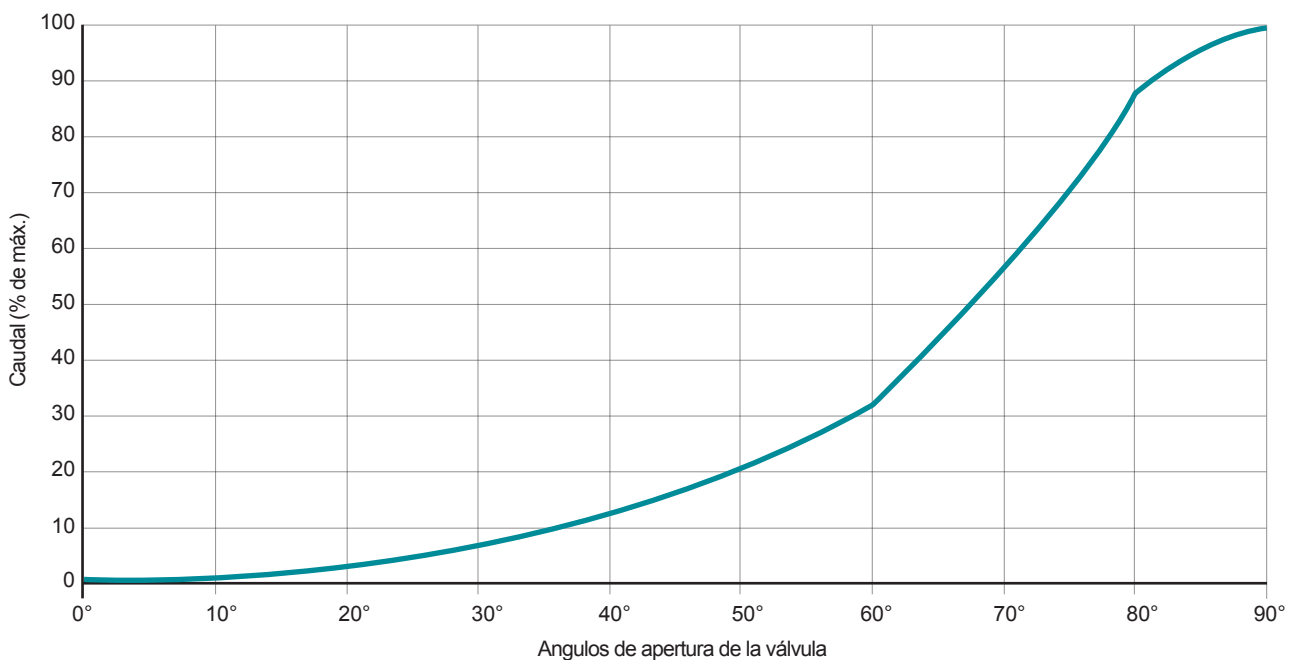



Designación de la válvula

D1 0100 . 3 3 - 2KR . 41 . 2AR . E - xx
 ① ② ③ ④ ⑤ ⑥ ⑦ ⑧ ⑨

①	Tipo de cuerpo	D1	Wafer	DN25-1000
		D3	Lug body	DN25-600
		D4	Sección en U	DN150-1600
②	Diámetro nominal	0025-1600	mm	
③	Presión de trabajo	0	2,5 bar	DN80-1600
		1	6 bar	DN350-1600
		2	10 bar	DN65-1600
		3	16 bar	DN25-1600
		4	20 bar (a petición)	DN25-600
④	Tipo de brida	**	PN6/10/16 vea tabla inferior. Otras normas bajo demanda	
⑤	Cuerpo	1AE	Fundición gris EN-GJL-250, revestimiento de poliuretano 80µ, pmax. 10 bar < 140°C	DN450-1400
		2KR	Fundición nodular EN-GJS-400-15, recubrimiento de Epoxy (Resicoat®) 200µ, Wafer y Lug < 110°C ¹⁾	DN25-300
		2AR	Fundición nodular EN-GJS-400-15, recubrimiento de Epoxy (Resicoat®) 200µ Sección en U < 110°C ¹⁾	DN150-300
		2AE	Fundición nodular EN-GJS-400-15, recubrimiento de Epoxy (Resicoat®) 200µ < 110°C ¹⁾	DN350-400
		2AN	Fundición nodular EN-GJS-400-15, recubrimiento de Polyurethan 80µ < 140°C	DN450-1600
⑥	Eje	41	Acero inoxidable 1.4021, AISI420	DN25-300
		42	Acero inoxidable 1.4542 / 17-4PH	DN25-300
		4A	Acero inoxidable 1.4021, AISI420	DN350-1600
		4L	Acero inoxidable 1.4542 / 17-4PH	DN350-1600
⑦	Disco	2AR	Fundición nodular EN-GJS-400-15, recubrimiento de Rilsan 250µ ²⁾ < 90°C	DN25-700
		2AE	Fundición nodular EN-GJS-400-15, recubrimiento de Polyurethan 80µ < 120°C	DN800-1600
		2AC	Fundición nodular EN-GJS-400-15, recubrimiento de Cromo	DN25-600
		2AH	Fundición nodular EN-GJS-400-15, recubierto de Halar min.600µ < 50°C	
		3OD	Acero 1.0552 / GS52.3, encapsulado en Ultralene Coating™ < 80°C, pmax. 10 ≤ DN300 / 6 bar > DN800	DN80-300, 800-1400
		4C0	Acero inoxidable 1.4408 ≈ CF8M ²⁾	
		4CP	Acero inoxidable 1.4408 ≈ CF8M pulido Ra < 0.4	DN25-600
		4CQ	Acero inoxidable 1.4408, recubierto de PEKK min. 600µ < 160°C	
		4S0	Acero Super austenítico 1.4588 PREN > 40	
		5C0	Bronce aluminio ASTM B148 C95800 / G-Cu Al 10 Ni	
⑧	Asiento	E	EPDM < 95°C pmax 16 bar (20 bar bajo demanda)	
		EE	EPDM DVGW, ACS, NSF-61, EN681-1 < 95°C pmax 16 bar	
		EC	EPDM HT < 130°C pmax 16 bar	
		N	Nitrilo (NBR) < 100°C pmax 16 bar (20 bar bajo demanda)	
		H	CSM (Hypalon) < 110°C pmax DN25-300 = 16 bar, DN350-1600 = 10 bar	
		V	FPM (Viton) < 200°C pmax DN25-300 = 16 bar, DN350-1600 = 10 bar	
			Otros materiales y asientos blancos y azules (con aprobación FDA y CE 1935/2004) bajo demanda	
⑨	Ejecuciones especiales	BL	Anillos de caucho vulcanizado pegados bajo demandanda	DN 450 -1600

1) Para temperaturas entre 100 y 140 °C, la válvula es solo estanca hasta el nivel de presión inferior (p.e. válvula PN16 solo admite 10 bar de presión)
 2) Aprobación NSF-61 sólo en combinación con asiento EE

**Tipo de brida (Código)

DESPONIA®	DN→	25	32	40	50	65	80	100	125	150	200	250	300	350	400	450	500	600	700	800	900	1000	1100	1200	1300*	1400	1500	1600												
	D1	PN6	3										1																											
		PN10	3										2																											
		PN16	3										2																											
		ANSI cl. 150	3										A																											
	D3	PN10	3										2																											
		PN16	3										2																											
		ANSI cl. 150	3										A																											
	D4	PN10									3	2																												
		PN16									3	2																												
		ANSI cl. 150									3	A																												

* Para DN1300 tamaño PN10 y PN16 bajo pedido.

Dimensiones

D1 Wafer, DN25-1000

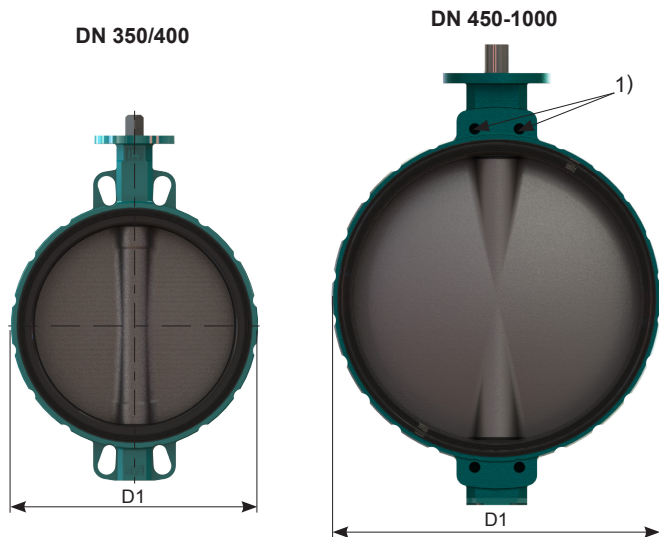
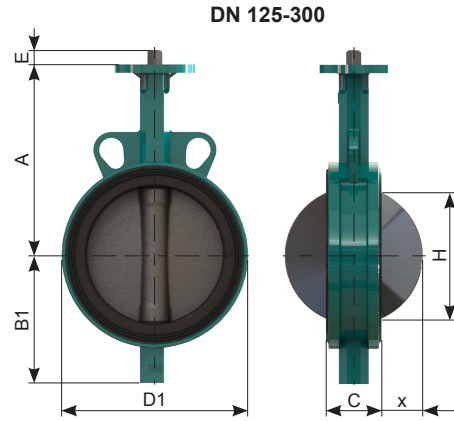
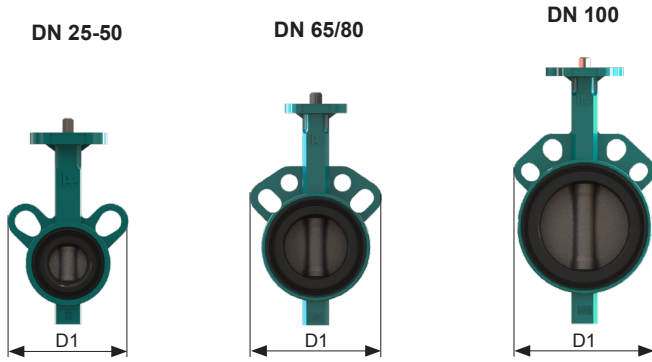

1) DN 450 - 1600, 2x La rosca en la zona del eje arriba y abajo

DN	A	B1	C	D1	E	H*	x*	[kg]
(25)32	110	51	30	101	12	19	3	1,0
40	130	55	33	108	12	28	6	1,3
50	135	72	43	123	12	32	6	1,62
65	150	82	46	138	12	50	11	2,3
80	160	92	46	143	12	69	19	2,3
100	180	110	52	161	12	88	26	3,9
125	195	128	56	181	16	115	36	5,0
150	210	141	56	205	16	141	48	5,9
200	240	174	60	260	19	194	72	9,3
250	279	201	68	310	24	240	91	17,0
300	315	234	78	362	24	290	112	23,7
350	330	268	80	425	40	330	130	41,5
400	365	299	102	475	40	377	145	57,2
450	397	355	113	538	65	425	164	95
500	437	393	126	595	65	474	182	120
600	522	464	153	695	80	569	218	180
700	565	501	168	800	80	660	257	265
800	627	577	190	919	80	774	304	343
900	696	643	204	1015	100	855	337	493
1000	745	693	218	1133	100	960	383	648

D3 Lug, DN 25-600

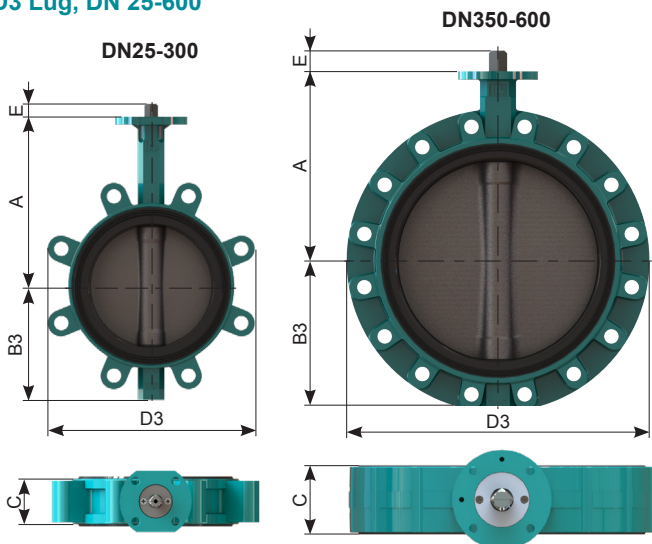

* Observe la cota H/x en especial durante el montaje de piezas de conexión hechas en plástico

DN	A	B3	C	D3	E	H*	x*	[kg]
25	110	51	30	103	12	19	3	1,4
32	110	51	30	103	12	19	3	1,4
40	130	55	33	110	12	28	6	2
50	135	72	43	123	12	32	6	2,3
65	150	82	46	162	12	50	11	4
80	160	92	46	176	12	69	19	6,1
100	180	110	52	204	12	88	26	8,5
125	195	128	56	232	16	115	36	10
150	210	141	56	256	16	141	48	11
200	240	174	60	322	19	194	72	19,6
250	279	201	68	383	24	240	91	28,7
300	315	234	78	436	24	290	112	41,2
350	330	258	80	520	40	330	130	62
400	365	290	102	584	40	377	145	75
450	397	355	113	655	65	425	164	143
500	437	394	126	712	65	474	182	156
600	522	464	153	829	80	569	218	180

Dimensiones

D4 Cuerpo con sección en U, DN 150-1600

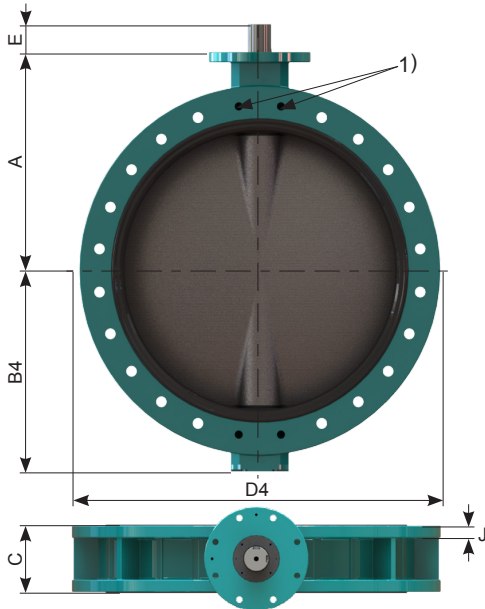

DN	A	B4	C	D4	H*	x*	J	E	[kg]
150	210	143	56	285	141	48	10	16	15
200	240	170	60	340	194	72	12,5	19	19,5
250	279	200	68	406	240	91	15	24	30,5
300	315	239	78	482	290	112	15	24	44
350	330	265	80	533	330	130	18	40	59
400	365	296	102	597	377	145	20	40	82
450	397	355	113	640	425	164	24	65	118
500	437	394	126	715	474	182	26	65	175
600	522	464	153	840	569	218	28,5	80	260
700	565	503	168	927	660	257	31,5	80	345
750	590	541	170	985	709	272	34	80	435
800	627	577	190	1060	774	304	36,5	80	510
900	696	643	204	1170	855	337	38	100	660
1000	745	693	218	1133	100	383	44	100	790
1100	820	738	218	1395	1054	429	44	120	850
1200	881	806	254	1512	1149	462	47	120	1180
1300	996	939	280	1654	1252	498	48	120	1530
1400	990	929	280	1742	1336	543	40	120	1700
1500 ²⁾	1096	1039	288	1854	1450	593	48	120	1850
1600	1117	1048	318	1924	1553	634	50	155	2600

- 1) DN 450 - 1600, 2x La rosca en la zona del eje arriba y abajo
- 2) Las dimensiones y el peso pueden variar y se confirmarán con el pedido.

Platina según la ISO 5211

Wafer y Lug

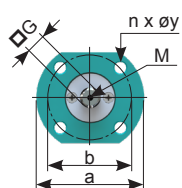
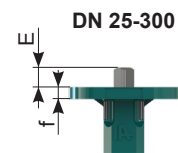

Sección en U

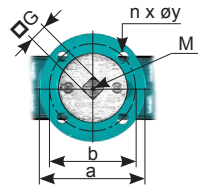
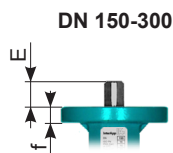

Wafer y Lug

DN	E	G	M	f	ISO	a	b	n x øy
25-40	12	□ 8	M4	10	F05*	65	50	4 x 7
50-80	12	□ 11	M6	10	F05	65	50	4 x 7
100	12	□ 11	M6	10	F05 / F07	89	50 / 70	4 x 7 / 4 x 9,5
125	16	□ 14	M6	10	F05 / F07	89	50 / 70	4 x 7 / 4 x 9,5
150	16	□ 14	M6	10	F07	89	70	4 x 9,5
200	19	□ 17	M6	10	F07	89	70	4 x 9,5
250-300	24	□ 22	**	18	F10/F12	150	102/125	4 x 11 / 4 x 13

*F04 bajo demanda

**Sin roscado en el eje

Sección en U

DN	E	G	M	f	ISO	a	b	n x øy
150	16	□ 14	M6	12	F07	90	70	4 x 9
200	19	□ 17	M6	12	F07	90	70	4 x 9
250-300	24	□ 22	**	18	F10/F12	150	102/125	4 x 11 / 4 x 13

**Sin roscado en el eje

Wafer, Lug y Sección en U

DN 350-400

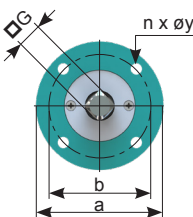
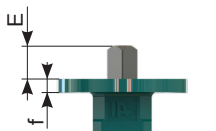

DN 450-1600

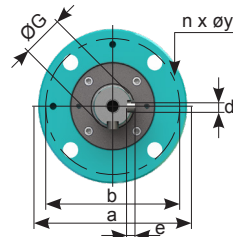
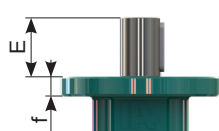

Wafer, Lug y Sección en U

DN	E	G	d	e	f	ISO	a	b	n x øy
350	40	□ 22	-	-	18	F12	155	125	4 x 13
400	40	□ 27	-	-	18	F12	155	125	4 x 13
450-500	65	Ø 45	14	9	25	F14	175	140	4 x 18
600	80	Ø 70	20	12	25	F16	220	165	4 x 22
700	80	Ø 70	20	12	25	F25	300	254	8 x 18
(750)	80	Ø 70	20	12	30	F25	300	254	8 x 18
800	80	Ø 70	20	12	30	F25	300	254	8 x 18
900	100	Ø 80	22	14	30	F30	350	298	8 x 22
1000	100	Ø 80	22	14	30	F30	350	298	8 x 22
(1100)	120	Ø 80	22	14	30	F30	350	298	8 x 22
1200	120	Ø 100	28	16	30	F30	350	298	8 x 22
1300	120	Ø 120	32	18	36	F30	350	298	6 x 22
1400	120	Ø 120	32	18	35	F30	350	298	8 x 22
1500 ¹⁾	120	Ø 120	32	18	35	F30	350	298	8 x 22
1600	155	Ø 130	32	18	40	F35	418	356	8 x 33,5

- 1) Las dimensiones y el peso pueden variar y se confirmarán con el pedido.

Dimensiones

Palanca Wafer y Lug

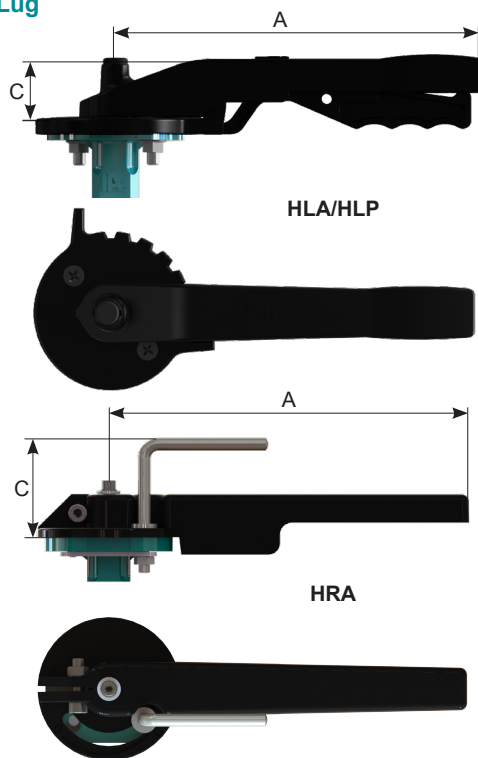

Aluminio, recubrimiento Epoxi

DN		A	C	[kg]
25-40	HLA.F0508.180-V2	180	41	0,4
50-65	HLA.F0511.180-V2	180	41	0,4
80	HLA.F0511.240-V2	243	43	0,5
100	HLA.F0711.240-V2	243	43	0,5
125-150	HLA.F0714.340-V2	340	51	0,6
200 ¹⁾	HLA.F0717.340-V2	340	51	0,6

Polyamida PA6 con 30% de fibra larga

DN		A	C	[kg]
50-80	HLP.F0511.240K	240	61	0,6
100	HLP.F0711.240K	240	61	0,6
125-150	HLP.F0714.390K	390	66	0,9
200 ¹⁾	HLP.F0717.390K	390	66	0,9

Aluminio, recubrimiento Epoxi

DN		A	C	[kg]
25-40	HRA.F0508.180-V2 ²⁾	180	64	0,4
50-65	HRA.F0511.180-V2 ²⁾	180	64	0,4
80	HRA.F0511.250-V2 ²⁾	250	64	0,5
100	HRA.F0711.250-V2	250	38	0,6
125-150	HRA.F0714.340-V2	340	38	0,6
200 ¹⁾	HRA.F0717.340-V2	340	38	0,6

1) Utilice un reductor para condiciones severas y ejecuciones *Labs Free* y *Fat Free*.

2) Plano de HRA F05 según ficha técnica HRA

Sección en U

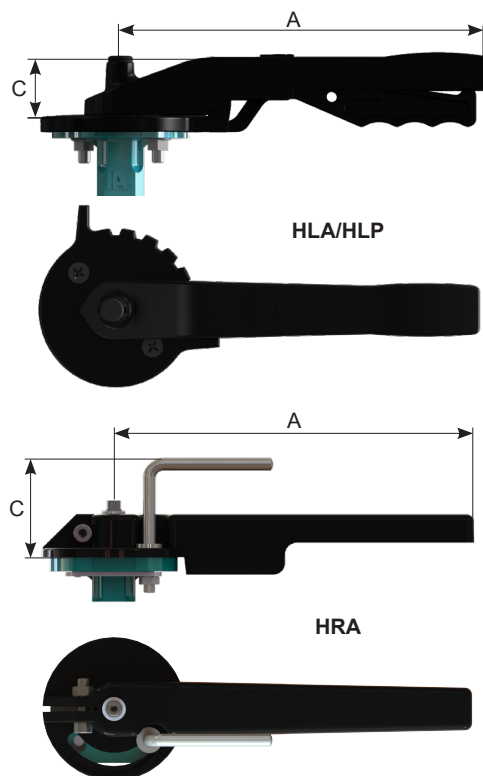

Aluminio, recubrimiento Epoxi

DN		A	C	[kg]
150	HLA.F0714.340-V2	340	51	0,6
200 ¹⁾	HLA.F0717.340-V2	340	51	0,6

Polyamida PA6 con 30% de fibra larga

DN		A	C	[kg]
150	HLP.F0717.390K	390	66	0,9
200 ¹⁾	HLP.F0717.390K	390	66	0,9

Aluminio, recubrimiento Epoxi

DN		A	C	[kg]
150	HRA.F0714.340-V2	340	38	0,6
200 ¹⁾	HRA.F0717.340-V2	340	38	0,6

1) Utilice un reductor para condiciones severas y ejecuciones LF y FF.

Dimensiones

Reductores

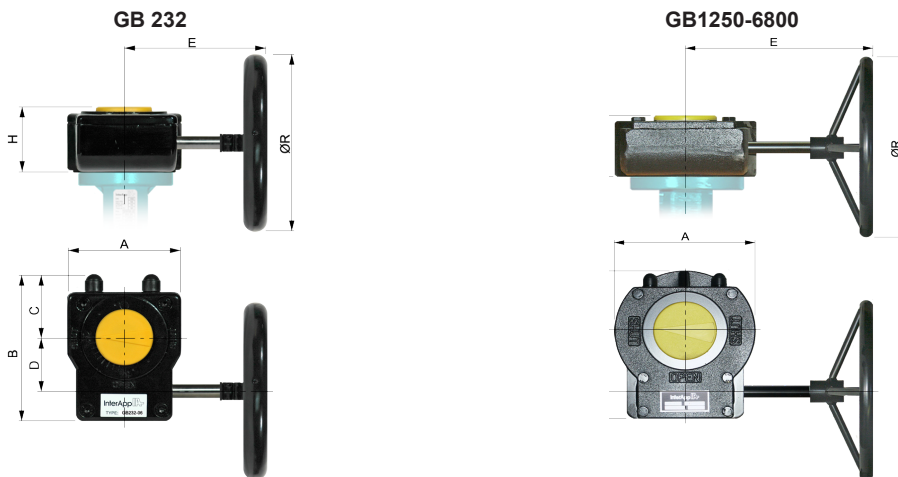

Para líquidos p_{max} DN25-300 ...16 bar, DN350-1600 ... 10 bar

DN		A	B	C	D	E	H	ØR	n*	[kg]
25-40	GB232-05.F05-F0708.100	80	114	48	42.5	121	53	100	10	0,8
50-100	GB232-05.F05-F0711.100	80	114	48	42.5	121	53	100	10	0,8
125-150	GB232-05.F05-F0714.100	80	114	48	42.5	121	53	100	10	0,8
200	GB232-06.F05-F0717.160	80	114	48	42.5	180	59	160	10	0,9
250-300	GB232-08.F07-F1022.250	100	131	56	50	216	67	250	9,25	1,55
350	GB232-13.F10-F1222.300	175	209	83	80	361	84	300	10	5,4
400	GB232-13.F10-F1227.500	175	209	83	80	396	84	500	10	5,4
450	GB1250N.F1445.400	220	258	110	104,5	326	102	400	13.75	22
500	GB1250N.F1445.400	220	258	110	104,5	326	102	400	13.75	22
600	GB2000N.F1670.500	241	255	106	53	348	121	500	27	24
700	GB2000NLB.F2570.600-SH100	285	293	142	53	348	121	600	27	27
750	GB2000NLB.F2570.700-SH100	285	293	142	53	348	121	700	27	27
800	GB1950N/PR4.F2570.500	285	322,5	142,5	130	417	126	500	54	39
900	GB1950NLB/PR4.F3080.500-SH100	350	355	175	130	445	129	500	54	52
1000	GB6800N/PR4.F3080.500	370	407	170	182	470	159	500	81	62,5
1100	GB6800N/PR4.F3080.500	370	407	170	182	470	159	500	81	62,5
1200	GB6800N/PR4.F30100.600	370	407	170	182	480	159	600	117	62,5
1300	GBA200N/PR10.F30120.400	440	492	207.5	209	480.5	215	400	182,25	133,4
1400	GBA200N/PR10.F30120.700	440	492	207.5	209	490.5	215	700	182,25	134,4
1500	GBA250N/PR10.F30120.500	510	585	235	256	530	224	500	182,25	222
1600	GBIW82/R720.F35130.800	520	531	260	67	600,5	185	800	130	222

* n = Vueltas del volante de apertura/cierre

Material:

GB232 :Aluminio, recubrimiento de poliuretano

GB880-GB6800 :Fundido, recubrimiento de poliuretano

Instalación como final de línea

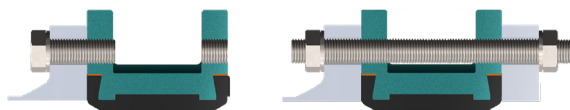

En caso de instalar la válvula como final de línea, por favor consultar la documentación de instalación y montaje de DESPONIA®

Mas documentación

Actuadores neumáticos, Actuadores eléctricos, Accesorios en hojas separados.

Instrucciones de instalación, Instrucciones de mantenimiento, Tablas de bridas: Observe por favor estas instrucciones para la instalación y mantenimiento de nuestras válvulas.

Los datos técnicos son orientativos y no vinculantes. Siempre son válidas nuestras condiciones generales de venta. Reservados todos los derechos.

© 2023 InterApp AG, all rights reserved