

## BI-DIRECTIONAL KNIFE GATE VALVE XD SERIES



KGV XD SERIES SEMI LUGGED WITH RISING STEM AND HANDWHEEL



KGV XD SERIES SEMI LUGGED WITH RUBBER LINED PASSAGE AND HANDWHEEL RS



KGV XD SERIES FULLY LUGGED WITH BONNET & HANDWHEEL NRS

The XD series knife gate is a Bi-directional resilient seated valve with frontal upper sealing designed to handle waste water, mud, vacuum pump systems and general liquid mediums. The design of the body and seat ensures a bubble-tight shutoff in both directions of the flow.

#### GENERAL FEATURES

- 100 % water tight in both senses
- U-seat with a steel stiff core vulcanized, fixed between the two bodies by screws.
- Without stuffing box
- Frontal elastomeric upper sealing
- Two split body arrangements: semi lugged (wafer) and optionally, fully lug-between flanges and fully lug-end valve without counter flange.
- Short face-to-face dimension
- Smooth and unobstructed full flow passage, no cavity or void in body, means no clogging
- Easy drive replacement
- Self cleaning design; little maintenance required
- Proximity and limit switch mounting points









#### APPLICATION FIELDS

- Wastewater treatment
- Fish handling
- Cruises and shipts
- Biomass
- Tunnel boring
- Plastic recycling plants
- Food and beverage
- Etc.

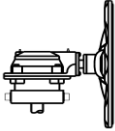
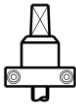
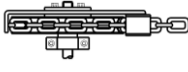
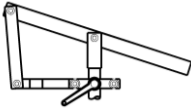
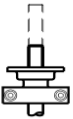
#### TECHNICAL DATA

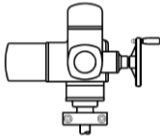
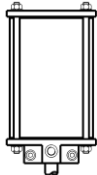
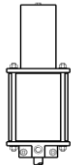
- **Size range:**  
DN-50 (2") to DN-1800 (72")
- **Working pressure:**  
DN 50 to DN 200: 10 kg/cm<sup>2</sup>  
DN 250 to DN 300: 7 kg/cm<sup>2</sup>  
DN 350 to DN 400: 6 kg/cm<sup>2</sup>  
DN 450 to DN 600: 4 kg/cm<sup>2</sup>  
DN 700: 3 kg/cm<sup>2</sup>  
DN 800: 2 kg/cm<sup>2</sup>  
DN 900: 1,5 kg/cm<sup>2</sup>  
DN1000 to DN1800: 1 kg/cm<sup>2</sup>
- **Flange ratings:**  
PN10, PN16 and ANSI B16.5 (class 150)  
Note: other flange drillings under request
- **Face to face dimension:**  
According to K1 DIN3202 up to DN-350
- **Coating:**  
RAL 5017, 150 microns epoxy coated
- **Directives:**  
Pressure equipment directive 97/23/CE  
DIR 2006/42/CE (MACHINES)  
DIR 94/9/CE (ATEX)  
Approved certificate for potable water  
(ACS-Atestation De Conformite Sanitaire)

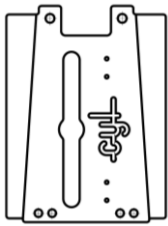
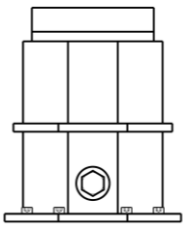
ASSEMBLY CONFIGURATION

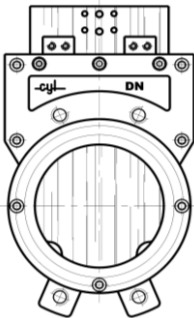
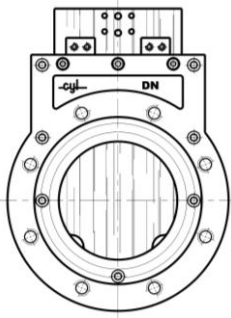
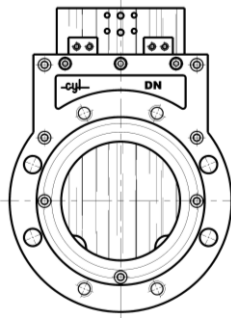
	STANDARD	OPTIONAL				
OPERATION						
	Rising stem handwheel	Non rising stem handwheel	Gearbox	Key Cap	Chain Wheel	Quick closing lever
OPERATION						
	Rising stem coupling A	Non rising stem coupling B-3	Electric actuator	Double acting pneumatic actuator	Spring-return pneumatic actuator	Oil hydraulic actuator
PLATES						
	Plates		Tight closed bonnet		Earth bonnet	
BODY						
	Semi lugged (wafer)		Fully lugged - end valve (All holes threaded)		Fully lugged - between flanges (partly tapped and partly through holes)	
ACCESSORIES	<ul style="list-style-type: none"> <li>- Revolving handle</li> <li>- Locking device</li> <li>- Overriding actuator</li> <li>- Limit stroke</li> <li>- Mechanical limit switches</li> <li>- Proximity limit switches</li> <li>- Mechanical position indicator</li> <li>- V-port (Aisi 316)</li> <li>- Deflector cone (Ni-hard)</li> <li>- Chest scraper (Bronze / PPS plastic)</li> <li>- Solenoid valve</li> <li>- Extension, extended guided plates</li> <li>- Etc</li> </ul>					

MATERIAL SPECIFICATION & PART LIST

No.	DESCRIPTION	MATERIAL
001	Body	Cast iron - GJL250 (standard) Ductile iron - GJS400, CF8M, DUPLEX 2205, SMO 254 (optional)
007	Seat	NBR (standard) PTFE, VITON, EPDM, SILICONE (optional)
002	Gate	SS 316 (standard) SS 316L, SS 316TI, DUPLEX 2205, SMO 254 (optional)
047	Packing material	NBR (standard) PTFE, VITON, EPDM, SILICONE (optional)
T	Screws and nuts	A-4
008	Push rods	SS 316
071	Plates	1.0580 (standard) SS 316 (optional)
-	Stem	SS 316
-	Bearing	1.0401 (standard) SS 316 (optional)
-	Handwheel	1.0037
-	Pneumatic act.	Aluminium

Figure 1. Exploded view of KGV XD series semi lugged

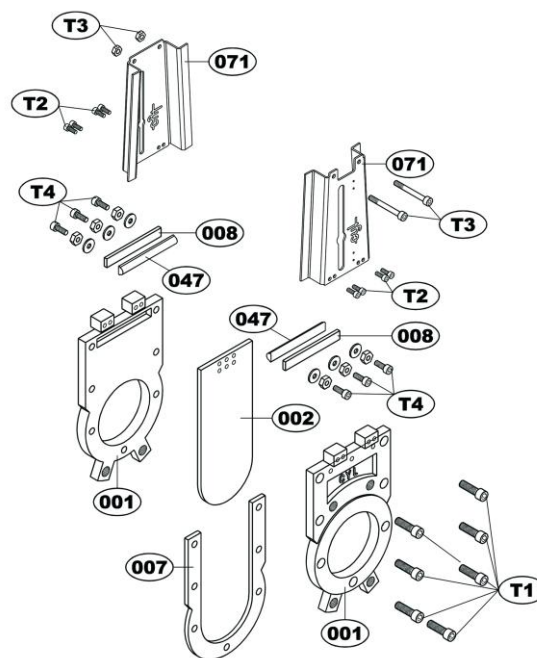

**SEAT TYPE**

The seat consists of one piece vulcanized u-shaped rubber seat (optionally PTFE) with steel stiff core inside, fixed between the two half bodies by screws, providing a bubble-tight shut off on both directions and, avoiding at the same time any build-up of fluids inside the body that would prevent the valve from closing.

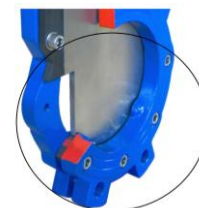

APPLICATION AND TEMPERATURE RANGE

SEAT AND PACKING MATERIALS			
Material	Min. temperature (°C)	Max. temperature (°C)	APPLICATIONS
NBR	-30	+80	Hydrocarbons and biogas waste
EPDM	-30	+90	Clean and chlorided water
EPDM-POTABLE	-30	+90	Approved certificate for potable water
VITON	-40	+180	Organic acids, hydrocarbons and heat resistant
PTFE	-10	+200	Heat, acids, chemical and corrosion resistant
POLIURETHANE	-10	+80	Abrasive mediums/mineral handling
WHITE NBR	-10	+60	Food industry
RED SILICONE	-20	+180	Food industry (FDA conformity)

\*More details and other sealing materials under request.

## DIMENSIONAL DRAWINGS

Figure 2. KGV XD series semi lugged rising stem & handwheel

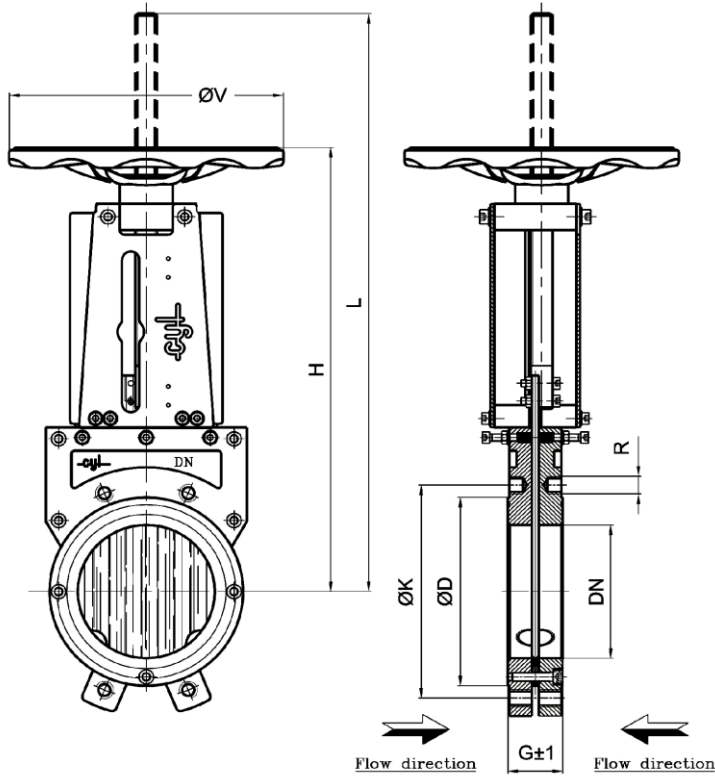

Figure 3. KGV XD series semi lugged rising stem with handwheel & gearbox\*

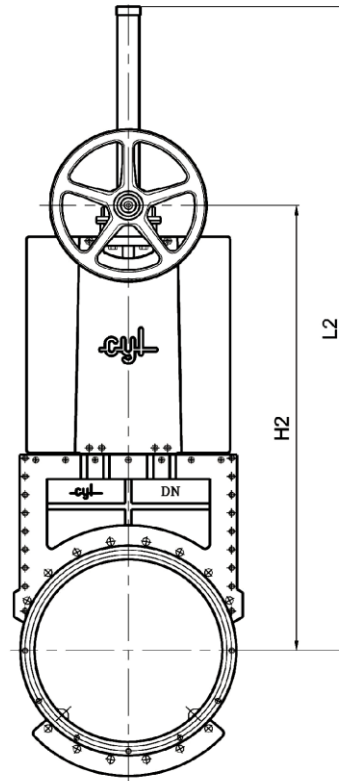
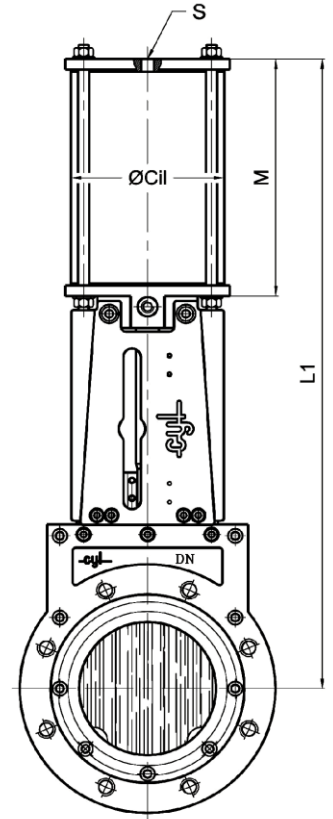

Figure 4. KGV XD series fully lugged with d/a pneumatic actuator



DN	G±1	L	H	ØV	L2	H2	L1	M	Ø Cil	S	Min. Torque (Nm)	Max. Torque (Nm)	Spindle thread
50	43	335	267	175	-	-	374	147	80	1/4 " G	8	16	Tr18x4i
65	46	376	293	175	-	-	413	160	80	1/4 " G	10	17	Tr18x4i
80	46	419	334	225	-	-	461	177	100	1/4 " G	12	19	Tr20x4i
100	52	476	371	225	-	-	518	197	100	1/4 " G	15	22	Tr20x4i
125	56	541	411	225	-	-	593	232	125	3/8 " G	17	24	Tr20x4i
150	56	651	500	300	-	-	709	267	160	3/8 " G	25	50	Tr24x5i
200	60	803	602	300	-	-	871	327	190	1/2 " G	27	53	Tr24x5i
250	68	954	703	300	-	-	1020	375	190	1/2 " G	50	69	Tr24x5i
300	78	1137	835	400	-	-	1194	428	190	1/2 " G	63	84	Tr28x5i
350	78	1273	921	400	1370	980	1351	499	250	1/2 " G	78	102	Tr28x5i
400	90	1433	1031	400	1530	1090	1511	549	250	1/2 " G	90	110	Tr28x5i
450	90	1604	1161	500	1667	1164	1664	590	300	1/2 " G	215	259	Tr40x7i
500	95	1779	1271	500	1829	1276	1838	656	300	1/2 " G	223	320	Tr40x7i
600	105	2066	1458	500	2116	1463	2125	757	300	1/2 " G	249	388	Tr40x7i

\* Valves above DN-600 need to be operated with gearbox.

\* Data sheet for ØK & ØD stated in "flange drillings chapter".

FLANGE DRILLINGS

**FLANGE DRILLING - PN10**

DN 50-65

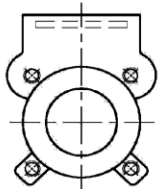

DN 80

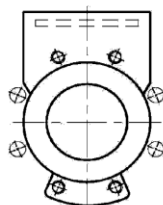

DN 100-150

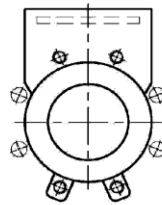

DN 200

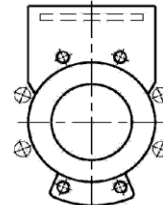

DN 250-300

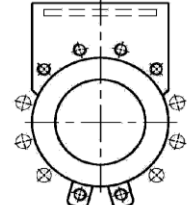

DN 350

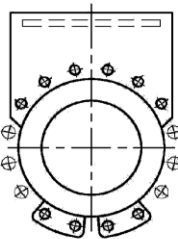

DN 400

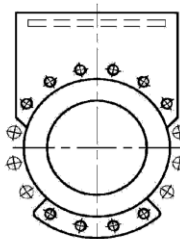

DN 450

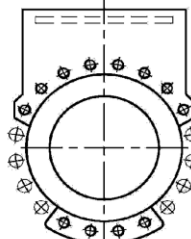

DN 500

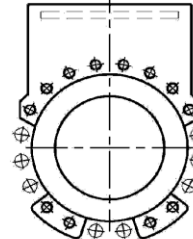

DN 600

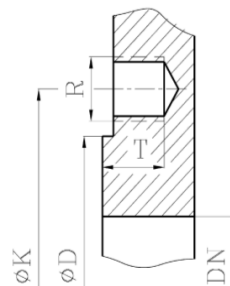
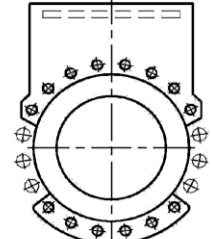

**Bolting Arrangements PN-10 Knife Gate Valve**

DN	K	D	N (1)	N (2)	N (3)	T	R
50	125	100	4	-	4	9	M-16
65	145	120	4	-	4	9	M-16
80	160	135	4	4	8	13	M-16
100	180	158	4	4	8	13	M-16
125	210	188	4	4	8	13	M-16
150	240	212	4	4	8	12	M-20
200	295	268	4	4	8	12	M-20
250	350	320	6	6	12	16	M-20
300	400	370	6	6	12	16	M-20
350	460	430	10	6	16	20	M-20
400	515	482	10	6	16	24	M-24
450	565	532	12	8	20	24	M-24
500	620	585	12	8	20	25	M-24
600	725	685	14	6	20	29	M-27

N (1)- Nº of tapped holes    N (2)- Nº of through holes    N (3)- Nº of flange holes



**FLANGE DRILLING - PN16**

DN 50-65

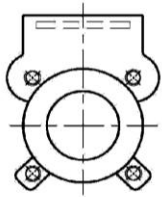

DN 80

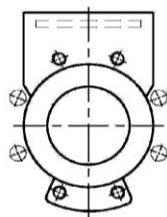

DN 100-150

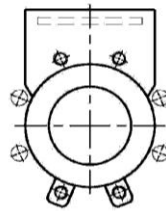

DN 200

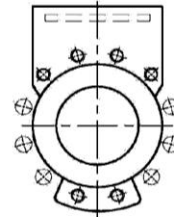

DN 250-300

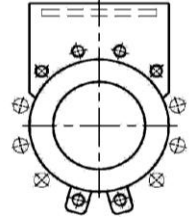

DN 350

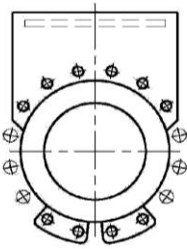

DN 400

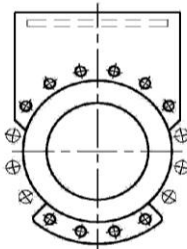

DN 450

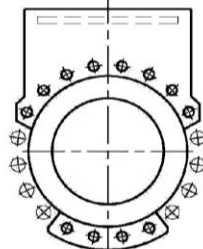

DN 500

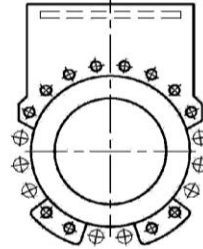

DN 600

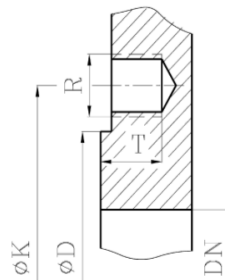
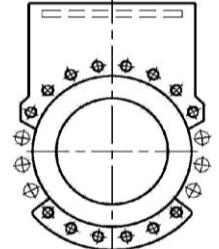

**Bolting Arrangements PN-16 Knife Gate Valve**

DN	K	D	N (1)	N (2)	N (3)	T	R
50	125	100	4	-	4	9	M-16
65	145	120	4	-	4	9	M-16
80	160	135	4	4	8	13	M-16
100	180	158	4	4	8	13	M-16
125	210	188	4	4	8	13	M-16
150	240	212	4	4	8	12	M-20
200	295	268	6	6	12	12	M-20
250	355	320	6	6	12	16	M-24
300	410	370	6	6	12	16	M-24
350	470	430	10	6	16	20	M-24
400	525	482	10	6	16	24	M-27
450	585	532	12	8	20	24	M-27
500	650	585	12	8	20	25	M-30
600	770	685	14	6	20	29	M-33

N (1)- Nº of tapped holes    N (2)- Nº of through holes    N (3)- Nº of flange holes

## FLANGE DRILLING - ASA 150

DN 50-65

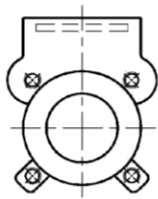

DN 80

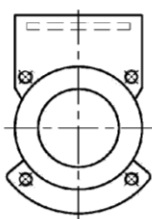

DN 100-150

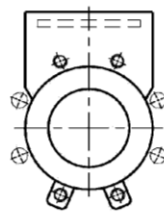

DN 200

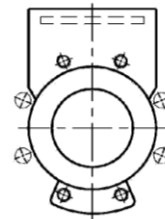

DN 250-300

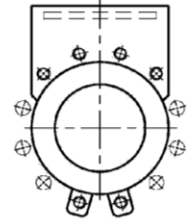

DN 350

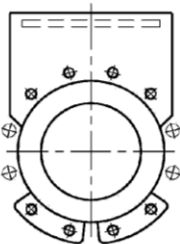

DN 400-450

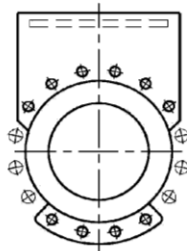

DN 500

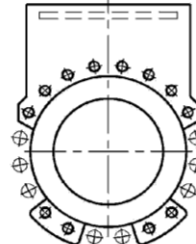

DN 600

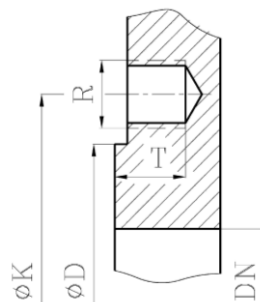
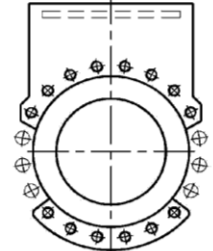

## Bolting Arrangements ASA 150 Knife Gate Valve

DN	K	D	N (1)	N (2)	N (3)	T	R
50	120,60	100	4	-	4	9	5/8 "
65	139,70	120	4	-	4	9	5/8 "
80	152,40	135	4	-	4	13	5/8 "
100	190,50	158	4	4	8	13	5/8 "
125	215,90	188	4	4	8	13	3/4 "
150	241,30	212	4	4	8	12	3/4 "
200	298,40	268	4	4	8	12	3/4 "
250	361,90	320	6	6	12	16	7/8 "
300	431,80	370	6	6	12	16	7/8 "
350	476,20	430	8	4	12	20	1 "
400	539,70	482	10	6	16	24	1 "
450	577,80	532	10	6	16	24	1 1/8 "
500	635,00	585	12	8	20	25	1 1/8 "
600	749,30	685	14	6	20	29	1 1/4 "

N (1)- Nº of tapped holes    N (2)- Nº of through holes    N (3)- Nº of flange holes

## ORDERING GUIDE

SERIES	OPERATIONS	BODY MATERIAL	DN	SEAT MATERIAL	BODY TYPE	FLANGE DRILLING
Example: XD	V	11		NI	W	PN-10
	V → Handwheel r.s	11 → Cast iron		NI → NBR	L → Fully Lugged (END VALVE)	PN-10
	VR → Handwheel r.s + Bevel Gearbox	12 → Ductile iron		EP → EPDM	LW → Fully Lugged (BETWEEN FLANGES)	PN-16
	F → Handwheel n.r.s.	14 → Stainless steel		VI → VITON	W → Semi lugged (WAFER)	ASA-150
	FR → Handwheel n.r.s. + Bevel Gearbox	17 → Fully stainless steel		TE → PTFE		AS-2129 Table C/D
	C → Key cap n.r.s	18 → Carbon steel		PU → POLIURETHANE		AS-2129 Table E
	CR → Key cap + Spur Gearbox			SI → SILICONE		
	B → Iso top flange r.s.			NIB → WHITE NBR		
	BR → Iso top flange r.s. + Bevel Gearbox					
	FB → Iso top flange n.r.s.					
	FBR → Iso top flange n.r.s. + Bevel Gearbox					
	M → Electric actuator r.s.					
	MR → Electric actuator r.s. + Bevel Gearbox					





SERIES	OPERATIONS	BODY MATERIAL	DN	SEAT MATERIAL	BODY TYPE	FLANGE DRILLING
	FM → Electric actuator n.r.s	11 → Cast iron		NI → NBR	L → Fully Lugged (END VALVE)	PN-10
	FMR → Electric actuator n.r.s + Bevel Gearbox	12 → Ductile iron		EP → EPDM	LW → Fully Lugged (BETWEEN FLANGES)	PN-16
	P → Quick closing lever	14 → Stainless steel		VI → VITON	W → Semi lugged (WAFER)	ASA-150
	N → D/A pneumatic actuator	17 → Fully stainless steel		TE → PTFE		AS-2129 Table C/D
	SE → S/A pneumatic actuator	18 → Carbon steel		PU → POLIURETHANE		AS-2129 Table E
	H → Oil hydraulic actuator			SI → SILICONE		
	VCH → Chain wheel r.s.			NIB → WHITE NBR		
	VCHR → Chain wheel r.s. + Bevel Gearbox					
	FCH → Chain wheel n.r.s.					
	FCHR → Chain wheel n.r.s. + Bevel Gearbox					